





**GENERAL
CATALOGUE
PLASTIC
BUILDING PRODUCT**

-  COMPANY PROFILE
-  MODULAR SYSTEMS
-  MULTIWALL SHEETS
-  SOLID SHEETS





INDEX

1

COMPANY PROFILE

1.1	Technology	page 06
1.2	Certification	page 07
1.3	Polycarbonate	page 08
1.4	Chemical resistance	page 09
1.5	Technical properties of multiwall sheets	page 10
1.6	Technical properties of modular systems	page 11
1.7	Light management "Progetto Caleido" line	page 12
1.8	product with IR treatment	page 13
1.9	Energy saving	page 14
1.10	Use and maintenance	page 15

2

MODULAR SYSTEMS

2.1	Modular interlocking systems	
	arcoPlus324	page 18
	arcoPlus625	page 22
	arcoPlus344x	page 24
	arcoPlus347-547	page 28
	Velario613	page 32
	Velario20-5	page 33
2.2	Modular connector systems	
	arcoPlus684-6104-6124	page 34
	arcoPlus684-6104-6124 Reversò	page 38
	arcoPlus626	page 42
	arcoPlus626 Reversò	page 46
2.3	Modular overlapping systems	
	arcoPlus1000	page 50
	arcoPlus1000 curvo	page 54
	arcoPlusSUPER1000	page 56
	arcoPlusSUPER1000 curvo	page 58
	arcoPlusGrecaClick	page 60
	arcoPlusMiniGreca	page 62
	arcoPlusMiniGreca curvo	page 64
	arcoPlusOnda	page 66
	arcoPlusOnda curvo	page 68
2.4	Opening systems	page 70

3

MULTIWALL SHEETS

3.1	multiwall sheets	page 74
-----	------------------	---------

4

SOLID SHEETS

4.1	solid sheets Policomp	page 80
4.2	solid sheets Scudo	page 85

	General terms and conditions of sale	page 86
--	--------------------------------------	---------





COMPANY PROFILE



Industrie Materie Plastiche Dott. Gallina was founded in 1960 by Pier Aulo Gallina, originally to manufacture profiles for the automotive industry. With developments in technology and the expansion of the market for thermoplastic materials, Dott. Gallina extended its range of products to include sectors such as construction and industry and is now a leading name on the international market.

The company currently has a workforce of some 170 people and production plants in Italy, Greece, Poland, the US and India.

Dott. Gallina manufactures plastic profiles for bodywork and upholstery for the automotive sector and supplies multiwall sheets, solid sheets and modular polycarbonate panels for roofing and glazing applications to the construction industry. These products are rapidly gaining ground in the marketplace for building materials due to their optical properties (transparency) similar to that of glass and superior mechanical and thermal characteristics.

Dott. Gallina is at the forefront of this development, committed to a policy of engineering and technological research, investing in leading-edge equipment and implementing strict quality control procedures.

The catalogue, with its new graphics and revised technical content, is a guide to our products and accessories that will help you choose the best solution depending on the type of application and technical specifications.

Our modular polycarbonate systems, multi-wall and solid polycarbonate sheets are innovative products and all guarantee good physical, mechanical and aesthetic properties.



OFFICES AND PRODUCTIONS SITE

SITES	REGIONS
ITALY	LA LOGGIA (TURIN) - DOTT.GALLINA (*)
SPAIN	MADRID - AISLUX S.A.
GREECE	KILKIS - GA PLASTICS S.A.
POLAND	TYCHY - DOTT.GALLINA POLAND (*)
US	JANESVILLE (WISCONSIN) GALLINA USA LLC (*)
INDIA	NEW DELHI - GALLINA INDIA (*)
FRANCE	PARIS
GERMANY	EBERSTADT
BELGIUM	BRUGES

*PRODUCTION SITE



1.1 TECHNOLOGY

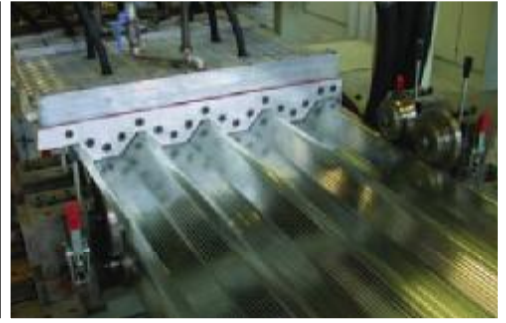

POLYCARBONATE IN THE CONSTRUCTION INDUSTRY

Polycarbonate is an innovative engineering plastic that is also versatile due to its transparency, good thermal insulation and impact strength. This makes it suitable for use in a wide range of residential and industrial building applications.

THE PRODUCTION PROCESS

Extrusion is a process used to produce continuously formed plastic multi-wall profiles and solid sheets.

U.V. PROTECTION

All products are co-extruded to ensure protection against exposure to ultraviolet radiation, extending their life and delaying the natural ageing of the material.

TECHNOLOGY



COEXTRUSION
Coextrusion observed with a microscope.

PoliCarb®

MULTIWALL SHEETS

PoliComp®

SOLID SHEETS

arcepPlus®

MODULAR SYSTEMS

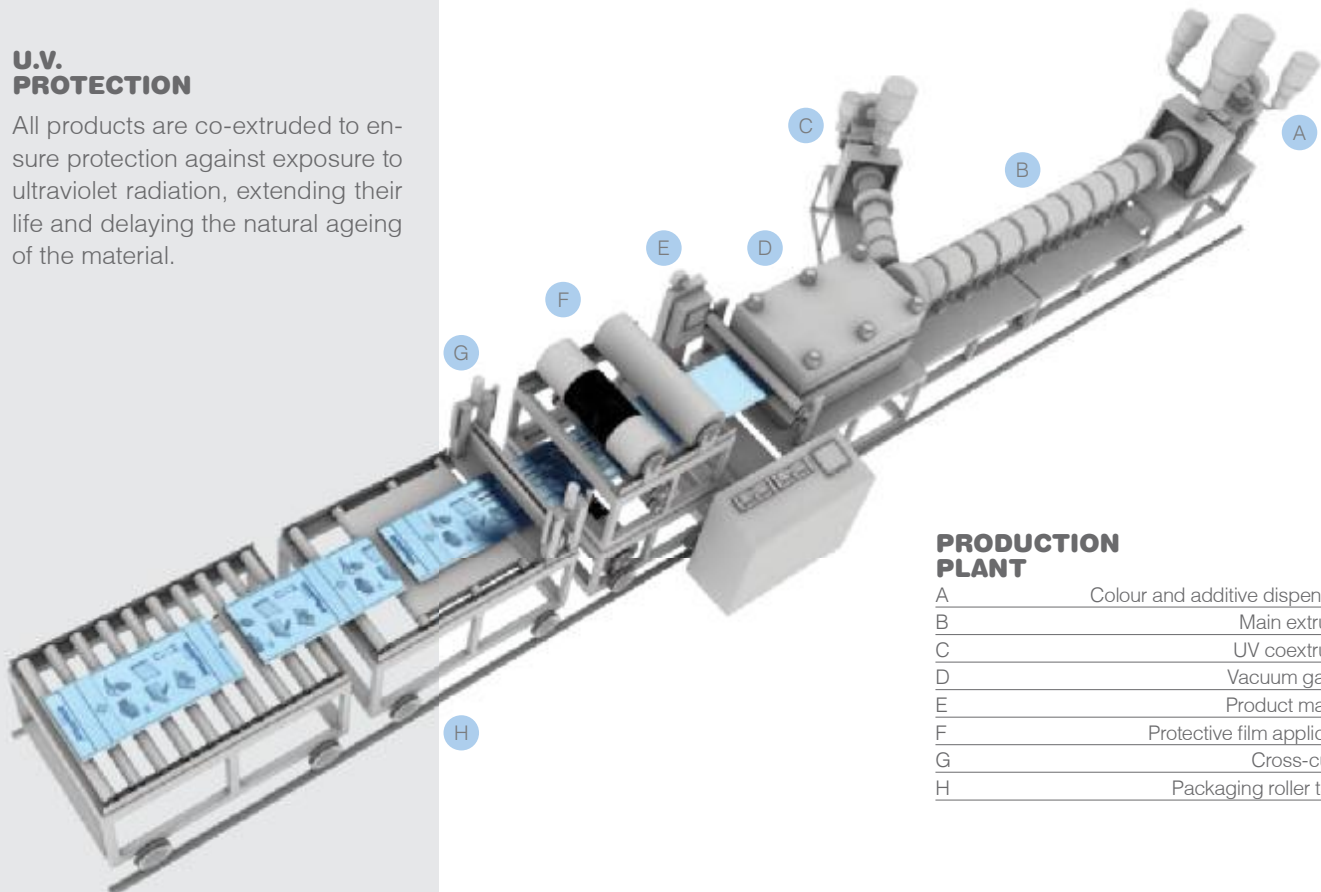

PRODUCTION PLANT

A	Colour and additive dispensers
B	Main extruder
C	UV coextruder
D	Vacuum gauge
E	Product marker
F	Protective film applicator
G	Cross-cutter
H	Packaging roller table



CERTIFICATION



1.2 CERTIFICATION

PRODUCT CERTIFICATION

Products are certified by authoritative laboratories and international bodies.

For further information please visit our website, www.gallina.it.



QUALITY SYSTEM

The company operates a quality system certified to:

ISO 9001

ISO 14001

ISO TS 16949



1.3 POLYCARBONATE

LIGHTWEIGHT

Polycarbonate is a lightweight material that is used in the construction industry to reduce building costs while guaranteeing compliance with positive and negative wind load requirements.

TRANSLUCENT

A key feature of polycarbonate is its transparency. The use of natural lighting, achieved by installing translucent polycarbonate roofing and walls, creates a more comfortable ambience while also ensuring good thermal insulation. Polycarbonate can be suitably tinted to modulate light transmission, optimise shading and thus reduce overheating inside the building. Coloured pigments are used to satisfy the most demanding aesthetic and architectural requirements.

VERSATILE

We supply an extensive range of products for use in the construction of translucent roofing and walls, skylights, fixed and openable insulated windows.

Our continuous research has led to the development of a series of steel and aluminium accessories to complete the range.

These are designed to make installation simple and safe and ensure compliance with the applicable fire and load strength ratings and safety of building requirements. Our products are all certified to the latest thermal insulation and energy saving standards.

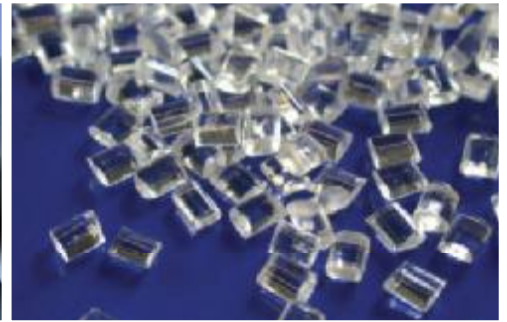

POLYCARBONATE

PHYSICAL PROPERTIES

	value	test method
Density	1.200 Kg/m ³	ISO 1183 - DIN 53479
Water absorption	± 0.19 %	ASTM D570

OPTICAL PROPERTIES

	value	test method
Light transmission	89 %	ASTM D570
Refraction index	1.58	ISO 489 - DIN 54391

MECHANICAL PROPERTIES

	value	test method
Resistance to tensile stress	66 MPa	ISO R527 DIN 53455
Resistance to yield stress	60 MPa	ISO R527 DIN 53455
Tensile modulus	2.300 MPa	ISO 178
Elongation at break	150 %	ISO R527 DIN 53455
Izod impact	860 J/m	ISO 180/4A

THERMAL PROPERTIES

	value	test method
Application temperature	-40 +120°C	
Linear thermal expansion	0,065 mm/m°C	
Vicat (B/50)	151 °C	ISO 306 - DIN 53460

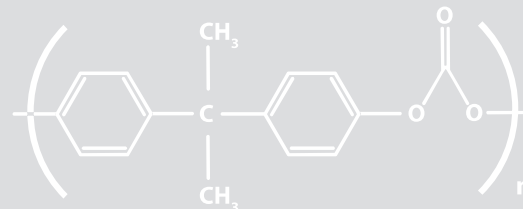

UV AND HAIL-RESISTANT

The exterior surface of the panel is co-extruded with high-performance UV-absorbing polycarbonate to ensure excellent protection against ultra-violet rays, hail and accidental impacts even after prolonged exposure to sunlight.

SAFE

Polycarbonate has a particularly high impact strength. Our products are therefore highly resistant to accidental impacts and hail and meet the requirements of safety standards for translucent glazing in public and work environments.

AN ENVIRONMENTALLY FRIENDLY MATERIAL

The various phases of polycarbonate processing involve very low energy consumption and environmental impact.

Polycarbonate is an energy-efficient solution and is totally recyclable at the end of its life.



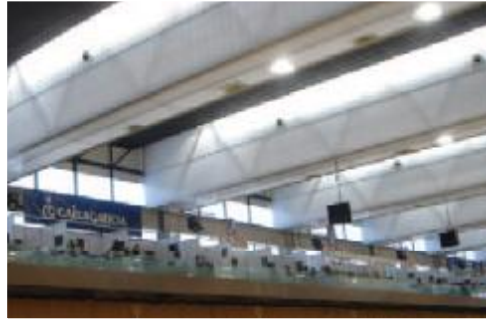

1.4 CHEMICAL RESISTANCE

CHEMICAL RESISTANCE

	AGENT	VARIATION
ALCOHOLS	Methyl alcohol	Cracking
	Ethyl alcohol 50%	Unchanged
	n-Butyl alcohol	Unchanged
	Ethylene glycol	Unchanged
ALKALI	Sodium hydrate 1%	Unchanged
	Sodium hydrate 10%	Clouding
	Ammonium hydrate 10%	Browning
	Calcium hydrate 10%	Unchanged
INORGANIC ACIDS	Hydrochloric acid 35%	Cracking
	Hydrochloric acid 10%	Unchanged
	Sulphuric acid 70%	Unchanged
	Sulphuric acid 30%	Yellowing
	Nitric acid 40%	Yellowing
	Nitric acid 10%	Yellowing
INORGANIC SALTS	Cromic acid 10%	Unchanged
	Sodium chloride 10%	Unchanged
	Potassium nitrate 10%	Unchanged
	Potassium Bicrom. 10%	Yellowing
	Sodium sulphate 10%	Unchanged
	Ammonium chloride	Unchanged
	Sodium carbonate 10%	Unchanged
LUBRICATING OILS	Sodium bicarbonate 10%	Cracking
	Silicon oil	Unchanged
	Paraffin oil	Unchanged
PLASTIFIED	Machine oil	Unchanged
	Tricresyl phosphate	Clouding
	Diocetyl Adipate	Unchanged
	Butyl Stearate	Unchanged
ORGANIC ACIDS	Trimetil. foreign acid	Unchanged
	Acetic acid 70%	Unchanged
	Acetic acid 10%	Unchanged
	Formic acid 30%	Unchanged
	Lactic acid 5%	Unchanged
	Oxalic acid 10%	Unchanged
	Benzoic acid 10%	Unchanged
Oleic acid 100%	Unchanged	
VARIOUS	Benzol	Fast dissolution
	Toluol	Fast dissolution
	Industrial petrol	Yellowing - Cracking - Opacification
	Kerosene	Unchanged
	Naphtha Diesel	Unchanged
	n Heptane	Unchanged
	Methylethylketone	Clouding - Softening
	Acrylonitrile	Fast dissolution
	Vinyl acetate	Clouding - Softening
	Styrene	Clouding - Softening
	Ethylc ether (5 °C)	Swelling
	Diethylenetriamine	Dissolution
	Ethylenediamine	Dissolution
	Triethanolamine	Cracking
	Phenol 5%	Yellowing - Opacification
	Cresol 5%	Unchanged
	Formalin	Unchanged

Polycarbonate has good resistance to most chemicals with which it is likely to come into contact during normal use.

Specific tests are recommended for applications where the material is likely to come into contact with aggressive chemicals.

It is essential to verify their compatibility prior to use. The table at the side provides a summary of reactions with some of the main products used.

1.5 MULTIWALL SHEETS PROPERTIES

PoliCarb®

LIGHT TRANSMISSION (LT)

Different pigments are used to obtain different light transmission values.

The values indicated in the table are based on calculations performed at specialist laboratories.

SOLAR FACTOR (SF)

Incoming solar radiation is reflected, partially absorbed, and transmitted to the inside.

The solar factor indicated in the table is the ratio, expressed as a percentage, between the total energy transmitted to the inside and total solar radiation.

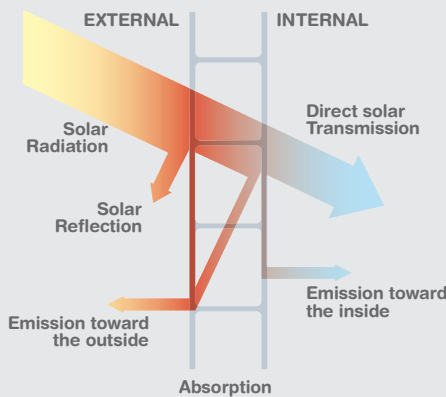

SHADING COEFFICIENT (SC)

The shading coefficient of a transparent sheet is the ratio between the sheet's solar factor and the solar factor of a clear sheet of glass with a thickness of 3mm ($SC = SF/0.87$).

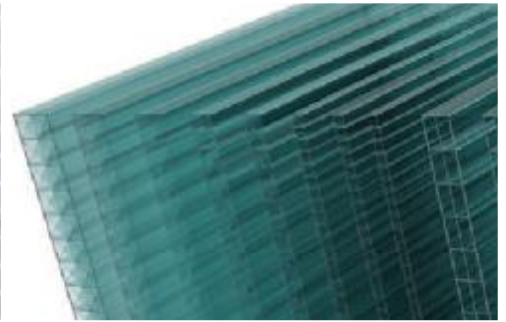
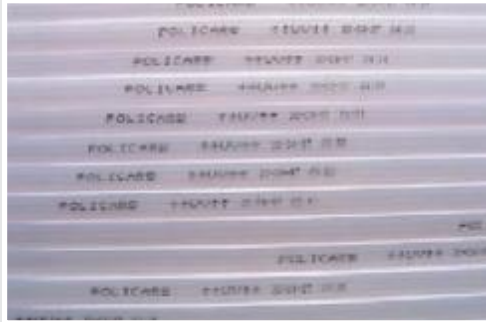

MULTIWALL SHEETS

Optical and Thermal properties (EN 16153)

PROFILE	LIGHT TRANSMISSION (LT) %	SOLAR FACTOR (SF) %	SHADING COEFFICIENT (SC)	THERMAL TRANSMITTANCE (U) W/m²K
Policarb 2P-4mm				3,9
Crystal	80	79	0,91	
Bronze	63	75	0,86	
Opal	50	66	0,76	
Policarb 2P-4,5mm				3,9
Crystal	80	79	0,91	
Bronze	63	75	0,86	
Opal	50	66	0,76	
Policarb 2P-6mm				3,6
Crystal	82	81	0,93	
Bronze	60	72	0,83	
Opal	50	66	0,76	
Policarb 2P-8mm				3,3
Crystal	82	80	0,92	
Bronze	65	75	0,86	
Opal	50	65	0,75	
Policarb 2P-10mm				3,0
Crystal	81	80	0,92	
Bronze	65	75	0,86	
Opal	50	64	0,74	
Policarb 16mm WIDE				2,5
Crystal	85	83	0,95	
Bronze	65	70	0,80	
Opal	50	65	0,75	
Policarb 3P-10mm				2,7
Crystal	74	75	0,86	
Bronze	65	72	0,83	
Opal	52	62	0,71	
Policarb 3P-16mm				2,3
Crystal	74	76	0,87	
Bronze	40	55	0,63	
Opal	52	57	0,66	
Blue	45	70	0,80	
Green	60	70	0,80	
Policarb 3P-20mm				2,1
Crystal	74	75	0,86	
Bronze	40	55	0,63	
Opal	52	63	0,72	
Policarb 4P-6mm				3,1
Crystal	79	78	0,90	
Opal	45	53	0,61	
Policarb 4P-8mm				2,7
Crystal	79	78	0,90	
Opal	45	53	0,61	
Policarb 4P-10mm				2,5
Crystal	79	78	0,90	
Opal	45	53	0,61	
Policarb 5P-16mm RDC				2,1
Crystal	66	70	0,80	
Bronze	30	45	0,52	
Opal	40	55	0,63	
Policarb 5P-20mm RDC				1,8
Crystal	63	67	0,77	
Bronze	28	43	0,49	
Opal	40	49	0,57	
Policarb 5P-25mm RDC				1,6
Crystal	60	64	0,74	
Bronze	27	41	0,47	
Opal	40	45	0,52	
Policarb 6P-16mm				1,8
Crystal	60	62	0,71	
Opal	40	45	0,52	
Policarb 6P-20mm				1,6
Crystal	58	60	0,69	
Opal	38	43	0,49	
Policarb 6P-25mm				1,4
Crystal	55	58	0,67	
Opal	35	40	0,46	
Policarb 7P-25mm				1,4
Crystal	58	62	0,71	
Opal	40	45	0,52	
Reflecto	40	40	0,46	
Policarb 7P-32mm				1,2
Crystal	57	61	0,70	
Opal	39	43	0,49	
Reflecto	35	37	0,43	
Policarb 7P-40mm				1,1
Crystal	55	59	0,68	
Opal	35	39	0,45	
Reflecto	33	35	0,40	



MODULAR SYSTEM

Optical, Thermal and acoustic properties (EN 16153)

PROFILE	LIGHT TRANSMISSION (LT) %	SOLAR FACTOR (SF) %	SHADING COEFFICIENT (SC)	THERMAL TRANSMITTANCE (U) W/m ² K	ACOUSTIC INSULATION dB
arcoPlus324				1,8	16
Crystal	70	74	0,85		
Green	65	70	0,80		
Bronze	60	67	0,77		
Opal	45	50	0,57		
arcoPlus625				1,7	16
Crystal	70	74	0,85		
Opal	52	57	0,66		
arcoPlus344x				1,9	19
Crystal	72	77	0,89		
Green	65	70	0,80		
Bronze	50	62	0,71		
Opal	49	60	0,69		
arcoPlus347				1,1	22
Crystal	65	70	0,80		
Green	60	65	0,75		
Bronze	40	47	0,54		
Opal	40	44	0,51		
arcoPlus547				1,1	22
Crystal	65	70	0,80		
Green	60	65	0,75		
Bronze	40	47	0,54		
Opal	40	44	0,51		
arcoPlus684				3,3	18
Crystal	70	71	0,82		
Blue	50	55	0,63		
Bronze	45	50	0,57		
Opal	42	55	0,63		
arcoPlus6104				3,0	18
Crystal	70	70	0,80		
Blue	50	55	0,63		
Bronze	45	50	0,57		
Opal	38	53	0,60		
arcoPlus6124				2,7	19
Crystal	68	70	0,80		
Blue	50	55	0,63		
Bronze	45	50	0,57		
Opal	36	52	0,60		
arcoPlus6166				1,8	20
Crystal	65	68	0,78		
Green	48	53	0,61		
Bronze	30	42	0,48		
Opal	40	45	0,52		
arcoPlus626				1,7	20
Crystal	58	62	0,71		
Green	48	53	0,61		
Bronze	40	45	0,52		
Opal	33	48	0,55		
Velario 613				2,7	16
Crystal	76	81	0,93		
Opal	58	65	0,75		
Velario 20-5				1,7	16
Crystal	70	74	0,85		
Opal	52	57	0,66		
arcoPlus1000				2,7	16
Crystal	70	74	0,85		
Opal	40	45	0,52		
arcoPlusSUPER1000				1,8	16
Crystal	65	66	0,76		
Opal	37	40	0,46		
arcoPlusGrecaClick				3,0	16
Crystal	70	74	0,85		
Opal	45	50	0,57		
arcoPlusMiniGreca				3,0	16
Crystal	70	74	0,85		
Opal	45	50	0,57		
arcoPlusOnda - 6mm				3,2	16
Crystal	73	77	0,89		
Opal	45	50	0,57		
arcoPlusAislux Polivalente				1,3	21
Crystal	60	65	0,75		
Reflecto	40	40	0,46		
arcoPlusAislux Aisluxecure				1,4	21
Crystal	58	62	0,71		
Opal	40	45	0,52		
arcoPlusAislux Complet				1,3	21
Crystal	58	62	0,71		
Opal	35	40	0,46		
arcoPlusAislux PS				1,3	21
Crystal	58	62	0,71		
Opal	35	40	0,46		
arcoPlusAislux PSV				1,3 (25mm) - 1,4 (30mm)	21
Crystal	60	64	0,74		
Opal	40	45	0,52		

1.6 MODULAR SYSTEM PROPERTIES



THERMAL INSULATION (U-VALUE)

Heat loss is normally defined as thermal transmittance and referred to in physics as the “U-value”. It is the rate of heat loss through a unitary surface per degree centigrade difference in temperature between the two sides and depends on the properties of the material of which the structure is made and the linear thermal transmittance conditions.

ACOUSTIC INSULATION

Sound insulation refers to the ability of the material to resist the transmission of impact sound. It varies according to the frequency and the physical properties, dimensions and installation constraints of the component.

PROGETTO Caleido

The line
Progetto Caleido
is dedicated to the
realisation of
facades and
coverings with
innovative aesthetic
and architectural
solutions.

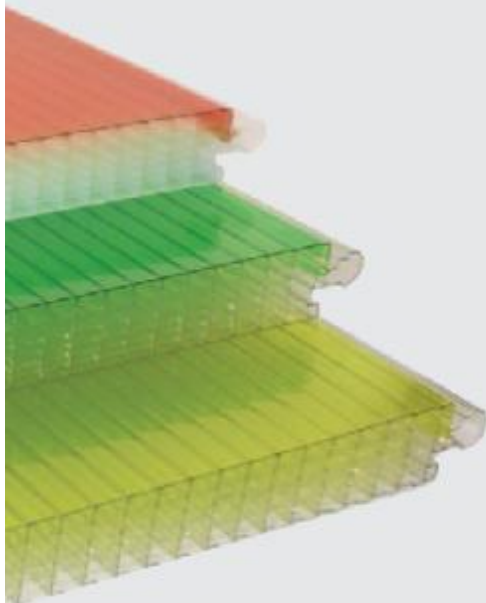
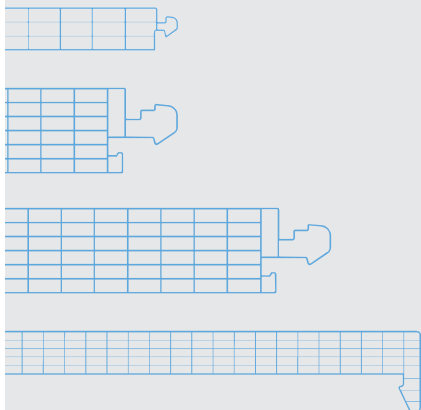

PRODUCT LINE

The arcoPlus® panels and the Polycarb® multiwall sheets can be colored to modulate the light transmission, optimize the shadow effect and allowing thereby for a lower heating of the internal environment.



All products available in the Progetto Caleido line are characterized by the indicated symbol.

THE PRODUCTION

The production of modular panels with transparent or translucent colors, and the use of the new double color technology, allows dott. Gallina to propose various solutions for applications on walls and as coverings.

The product line "Progetto Caleido" is made up of various modular systems.

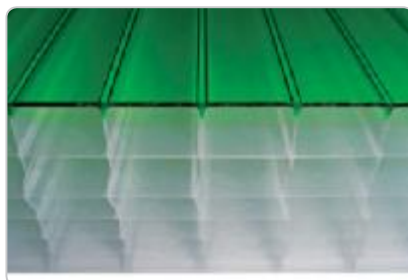

THE TECHNOLOGY OF DOUBLE COLOR

The new extrusion technology with double color allows to satisfy the chromatic needs of the project and at the same time to dose the light transmission recreating particular settings.

LIGHT MANAGEMENT

Transparent or translucent colors with the possibility to modulate light and color according to the needs of the customer.



NATURAL ILLUMINATION

Thanks to a natural illumination, obtained by the realisation of transparent coverings and walls in polycarbonate, high values of environmental comfort are gained maintaining a high rate of thermal isolation.

PRODUCT RELIABILITY

The safety of using proven composite systems of coextruded polycarbonate panels and aluminium profiles with a certificate and 10-year warrantee.





NEW PRODUCT RANGE

The Policarb®IR, Policom®IR sheets and arcoPlus®IR panels let light in but not heat. They make up Gallina's new product range for transparent coverings and windows with solar control. All products from the IR line offer innovative solutions for typical building applications where high levels of light are wanted while reducing the internal heating. The potential result: reduced energy spending for cool-

ing and for lighting as well as higher comfort. The new Policarb®IR sheets are available in all thicknesses and dimensions. The multiwall sheets, and the modular arcoPlus®IR panels offer incredible design flexibility in applications such as skylights, windows, greenhouses, conservatories, and many others thanks to the wide range of available products.

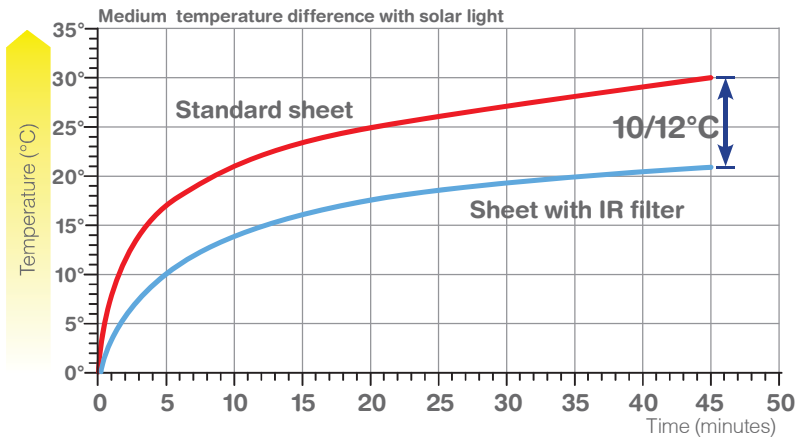

INTERNAL TEMPERATURE REDUCTION COMPARISON

Testing proves that products with a protective infra-red filter can significantly reduce internal heating.

NATURAL PROTECTION

The heat coming from solar heating is for the most part absorbed by the external surface, treated with IR absorbers, that limits radiation to the inside of the building and the consequent heating up.

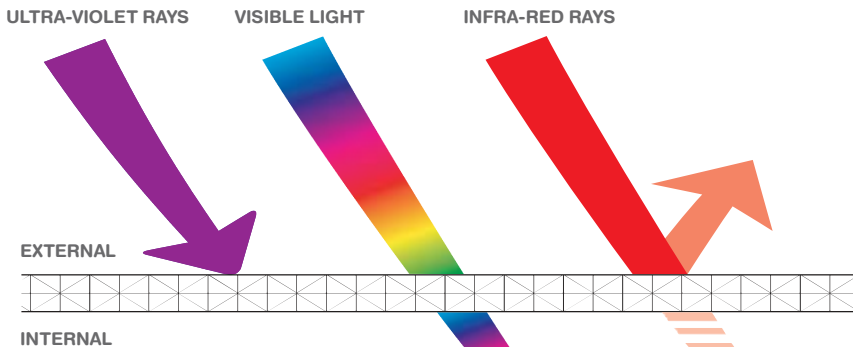

U.V. PROTECTION
all products in polycarbonate by Gallina are UV protected and block out the harmful ultra-violet radiation.

LIGHT TRANSMISSION
The Policarb®IR sheets and modular arcoPlus®IR panels transmit a higher quantity of light.

INFRA RED ENERGY
The Policarb®IR sheets and modular arcoPlus®IR panels transmit to the inside less infra-red energy.

1.8 POLYCARBONATE LINE OF FILTER PROTECTION IR

IR

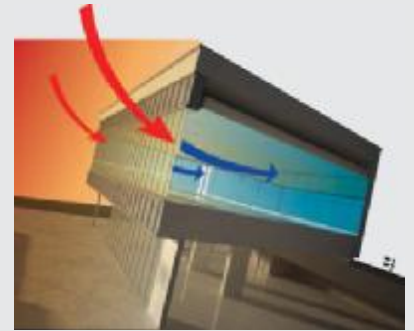

SOLAR CONTROL TO DEFEAT THE HEAT

The control of the temperature and the management of heat are essential elements in maintaining a desired level of comfort within buildings. They are also critical elements for cost control and to maximize energy savings. The products of the IR line absorb the part of the light relative to the infra-red rays (from 780 to 1400nm), effectively blocking the solar heat, while letting the solar light through.

The result is a reduction of the internal transmission of heat and a reduction of the cost for cooling the area. In fact all the products from the IR line can contribute to reducing the temperature increase up to 25% while increasing the light transmission by up to 60% with respect to other window products.

THE LASTING WARRANTY

All products from the line IR come with a written 10-year warranty against the reduction of its characteristics relative to light and solar transmission, turning yellow and breakage caused by hail.



All products available with the IR treatment are characterized by the indicated symbol.

1.9 ENERGY SAVING

ENERGY SAVING

The multi-wall structure of Polycarb® and arcoPlus® offers a real advantage in terms of thermal insulation. Calculated according to the guidelines of DIN 4701, there is a significant difference in fuel consumption between an industrial building with glass windows and the same building with multiwall polycarbonate glazing.



AR TREATMENT

In situation where a high efficiency of light transmission within a building is requested, through the AR treatment can have a better distribution of the light intensity on the surface, reducing reflections and dazzlings.

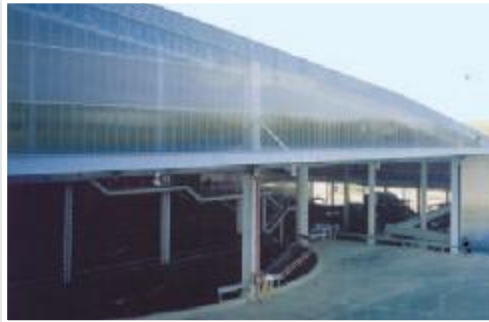

ENERGY SAVING

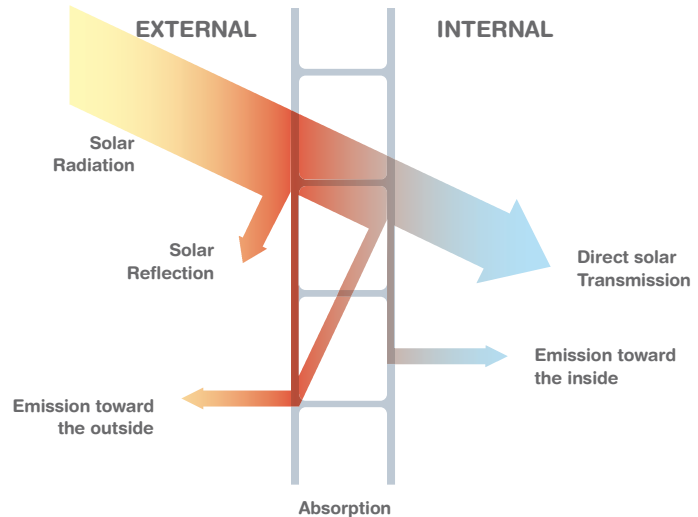

CALCULATION OF FUEL SAVING

The following formula is the calculation of fuel savings:

$$E = \frac{\Delta K \cdot S \cdot Gg \cdot 24}{Pt \cdot h}$$

Where:

- E Yearly fuel saving (Kg)
- ΔK Difference between thermal transmittance values of glass and polycarbonate (Kcal/hm²°C)
- S Windows surface (m²)
- Gg Seasonal heating factor (heated days per temperature average difference) (°C h)
- 24 Conversion factor
- PT Heating power of the employed fuel (Kcal/Kg)
- h Production of the heating plant (normal h=0,7)

ESTIMATE EXAMPLE : industrial shed

Location: Turin

(degree per day) 2570 • 24 = 61680 (degree per hour)

Gg • 24 = 61680 °C h

Surface: 1,40 (height) x 100 (boundary development)

S = 140 m²

Difference "ΔK": between U-GLASS 27 et arcoPlus344x (5,0 x 1,7) = 3,3 Kcal/hm² °C

ΔK = 3,3 Kcal/hm²°C

Fuel: oil-fire 10.200 Kcal/Kg

Pt = 10.200 Kcal/Kg

Plant production

h = 0,7

Therefore the yearly fuel saving will be:

$$E = \frac{3.3 \times 140 \times 62.808}{10.200 \times 0.7} = 4.064 \text{ Kg}$$

LOWER HEATING POWER OF FUEL

Electric power	2.300	Kcal/KWh
Oil-fired heating	10.200	Kcal/Kg
Methane	8.200	Kcal/m ³

SEASONAL HEATING FACTOR (DEGREE PER DAY)

Milan	2.340	°C
Rome	1.440	°C
Turin	2.570	°C
Palermo	690	°C



USE AND MAINTENANCE



Never store the material in a place where it is exposed to sunlight while wrapped in its protective film



Install the material with the U.V. protected side facing the exterior and remove the protective film after installing



Allow for thermal expansion of the material



Only use polycarbonate-compatible silicone if necessary



Use adhesive aluminium tape to seal the air cells



Use water and neutral soap to clean the surfaces



Use suitable hoisting equipment to handle the material

1.10 USE AND MAINTENANCE

CLEANING

To clean sheets and panels we recommend the use of water and neutral detergent only.
Do not use abrasive products.

THERMAL EXPANSION

Polycarbonate is subject to thermal expansion of 0.065 mm/m°C.
When installing polycarbonate sheets and panels always allow enough room for expansion.
If anchoring systems are used these must consist of the specific brackets and connectors provided for each product.

HANDLING

Take all the appropriate precautions when handling the material to avoid accidental impacts and scratches on the surface which could spoil the material's appearance and undermine its mechanical properties.

STORAGE

Avoid exposure to direct sunlight and rain to prevent any excessive build-up of heat in the packaging or the formation of condensation in the cells.
Do not remove the protective film before installing, but immediately after installation.

SEALING

Only use neutral, polycarbonate-compatible silicone for sealing.



MODULAR SYSTEMS

2.1 INTERLOCKING SYSTEMS:

This group of modular systems all have a tongue and groove connector system. The structure is specifically designed to ensure a weatherproof finish. All systems are supplied complete with a range of accessories to ensure correct installation. They are particularly suitable for roofing applications, continuous translucent glazing and false ceilings.

2.2 CONNECTOR SYSTEMS:

This group includes all the modular systems provided with a specific connector, depending on the type of application. All systems are supplied complete with a range of accessories to ensure correct installation. They are particularly suitable in roofing for covering large areas, translucent façades and glazing applications.

2.3 OVERLAPPING SYSTEMS:

This group of wall and roofing products can be used in continuous applications or with other insulated metal panels and corrugated sheets or panels. Their structural design and the use of a specific range of accessories guarantee a weatherproof finish.

2.4 OPENING SYSTEMS:

This group of products can be used with the modular interlocking systems to create opening windows.

All arcoPlus® systems include aluminium profiles and anchor systems to guarantee resistance to positive and negative wind loads while allowing for linear expansion.

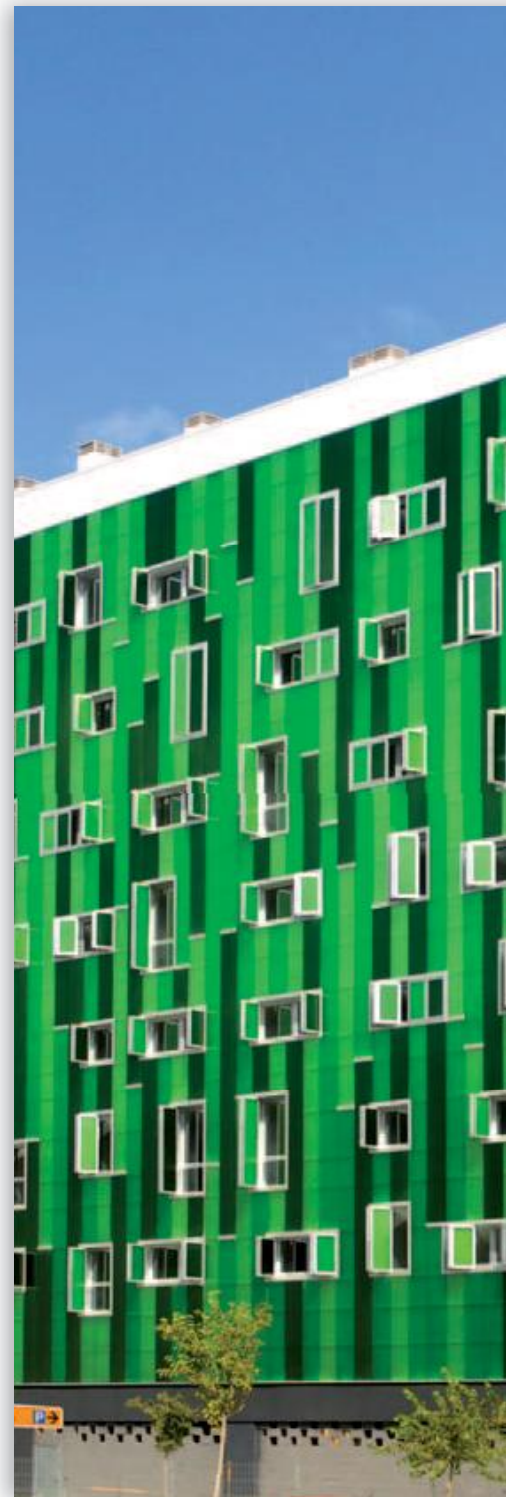

arcoPlus®



2.1 INTERLOCKING SYSTEMS

arcoPlus®
324



PROFILE

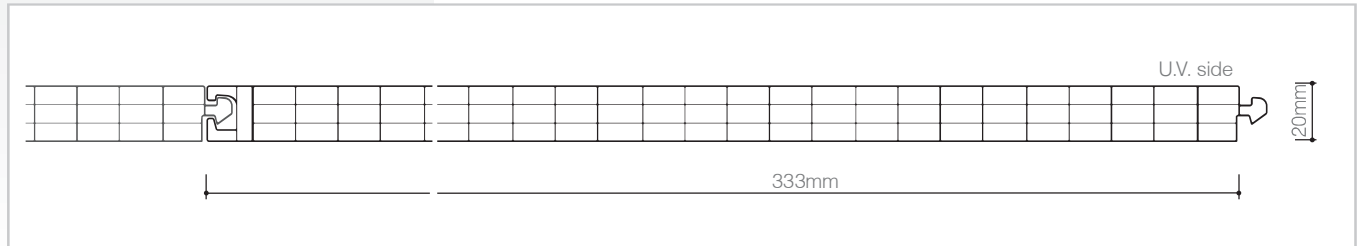

**Modular system of
UV protected multiwall
polycarbonate for
translucent curtain
walls and glazing
applications**

PRODUCTION STANDARDS

thickness	20mm
structure	4 walls
effective modular width	333mm
panel length	no limit
colours available	see page 11

TECHNICAL FEATURES

Thermal insulation	1,8 W/m ² K
Acoustic insulation	16 dB
Linear thermal expansion	0,065mm/m°C
Temperature range	-40°C +120 °C
U.V. rays protection	Coextrusion
Fire reaction EN 13501	EuroClass B-s1,d0

DESCRIPTION

arcoPlus®324 is a modular system of coextruded 4 walls polycarbonate panels with a thickness of 20mm, aluminium profiles, accessories and opening windows, designed for simple and versatile use.

arcoPlus®324 is not suitable for roofing applications.



LIGHT MANAGEMENT

ADVANTAGES

- ❖ Easy and low-cost installation
- ❖ Light transmission
- ❖ Resistance to U.V. rays and to hail
- ❖ Heat insulation

APPLICATIONS

- ▣ Vertical windows

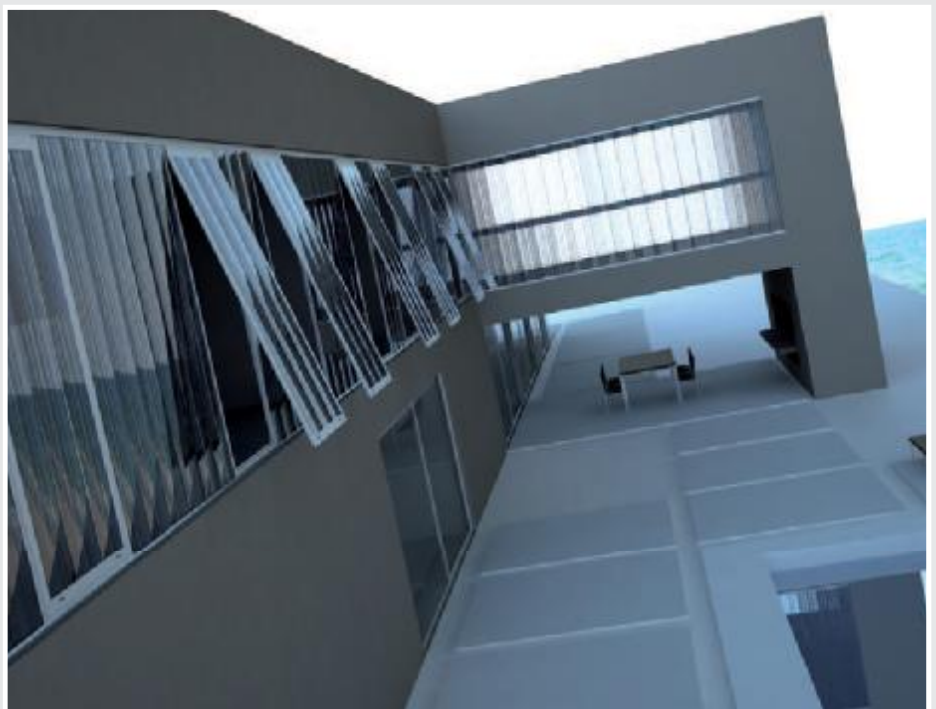



LOAD RESISTANCE

Maximum loads on two supports

Values below refer to product installed according to the Technical Handbook Recommendation

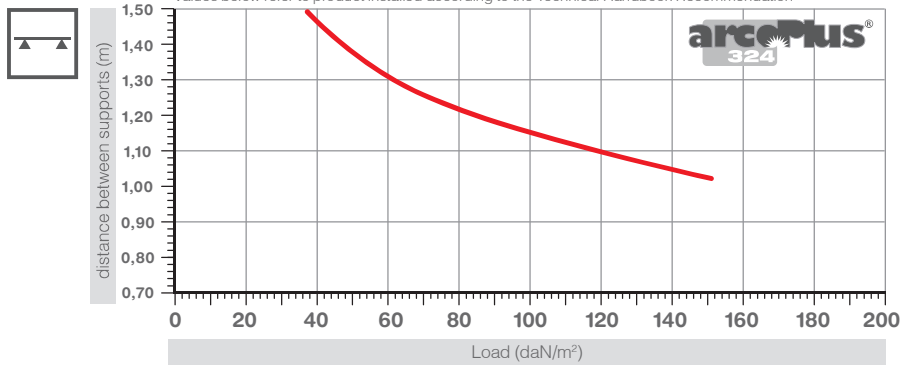

Maximum loads on more supports

Values below refer to product installed according to the Technical Handbook Recommendation

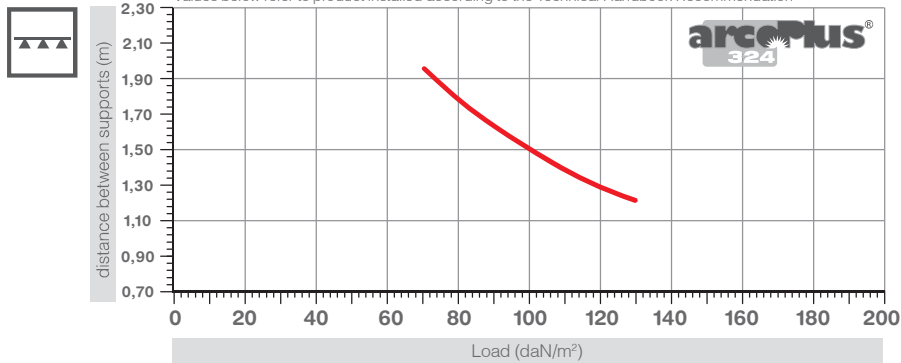

EASY AND LOW-COST INSTALLATION

The 20mm-thick, 4 walls structure with tongue and groove connection gives the panels remarkable flexural strength. It also allows the panels to be installed without the use of metal reinforcement frames, thus eliminating heat loss due to the thermal bridges caused by these structures.

The modular connection ensures a watertight seal for glazing with an inclination of up to 30°.

For installations exceeding 1.5m, a suitable section-breaker profile must be installed to which the arcoPlus® panels can then be fixed (see load resistance graph). This is done using the specific brackets to give the system

the necessary resistance to negative wind load and permit sliding due to thermal expansion.



INSERTION OF PLATE
Insertion of stainless steel plates for anchorage to existing structures.



**CALCULATION AND INSTALLATION
EXAMPLES OF PANEL LENGTH (PL)**

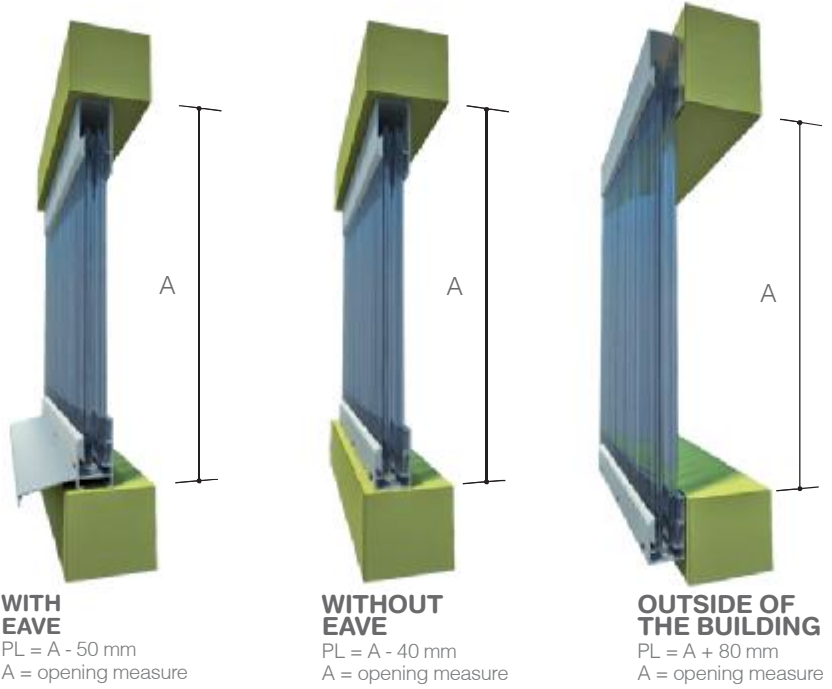

VERTICAL GLAZING
 Construction of continuous transparent
 glazing, with section-breaker profile.





ACCESSORIES

The system includes a complete range of aluminium profiles for installing the panels.

The air cells of the polycarbonate panels must be sealed using vented aluminium breather tape. This allows correct ventilation and prevents soiling on the inside.



BASE PROFILE
Insertion of curtain wall panels on base profile, with gasket.

METAL PROFILES

code 4062
Base AL profile

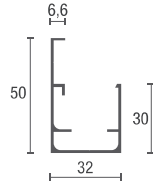

code 4064
Base AL profile with eave

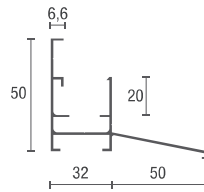

code 4061
Upper and side AL profile

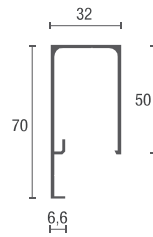

VERTICAL WINDOW
Positioning of anchor plates on section-breaker profile.

ACCESSORIES



4062
Base AL profile



4064
Base AL profile with eave



4061
Upper and side AL profile



1169/B
Slip Coat Gasket



4063
Link plate



4066
Additional sealing tape

2.1 INTERLOCKING SYSTEMS

arcoPlus®
625



PROFILE

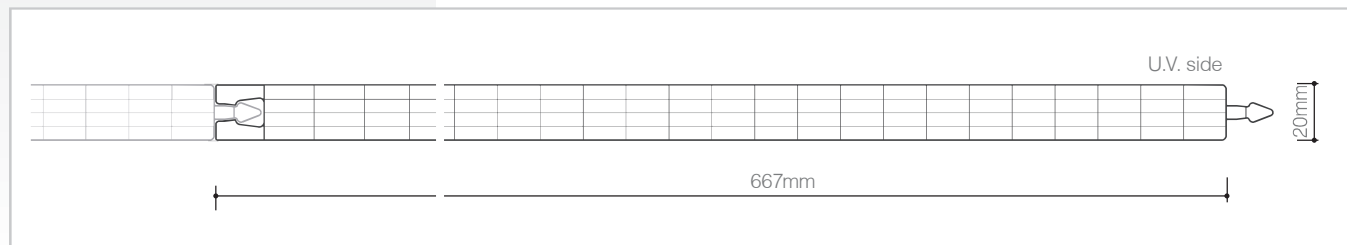

Modular system of UV protected multiwall polycarbonate for vertical window applications

PRODUCTION STANDARDS

thickness	20mm
structure	5 walls
effective modular width	667mm
panel length	no limit
colours available	see page 11

TECHNICAL FEATURES

Thermal insulation	1,7 W/m ² K
Acoustic insulation	16 dB
Linear thermal expansion	0,065mm/m°C
Temperature range	-40°C +120 °C
U.V. rays protection	Coextrusion
Fire reaction EN 13501	EuroClass B-s1,d0

DESCRIPTION

arcoPlus®625 is a modular system of coextruded 5 walls polycarbonate panels with a thickness of 20mm, aluminium profiles, accessories and opening windows, designed for simple and versatile use.

arcoPlus®625 is not suitable for roofing applications.



LIGHT MANAGEMENT

ADVANTAGES

- ❖ Easy and low-cost installation
- ❖ Light transmission
- ❖ Resistance to U.V. rays and to hail
- ❖ Heat insulation

APPLICATIONS

- ▶ Vertical windows

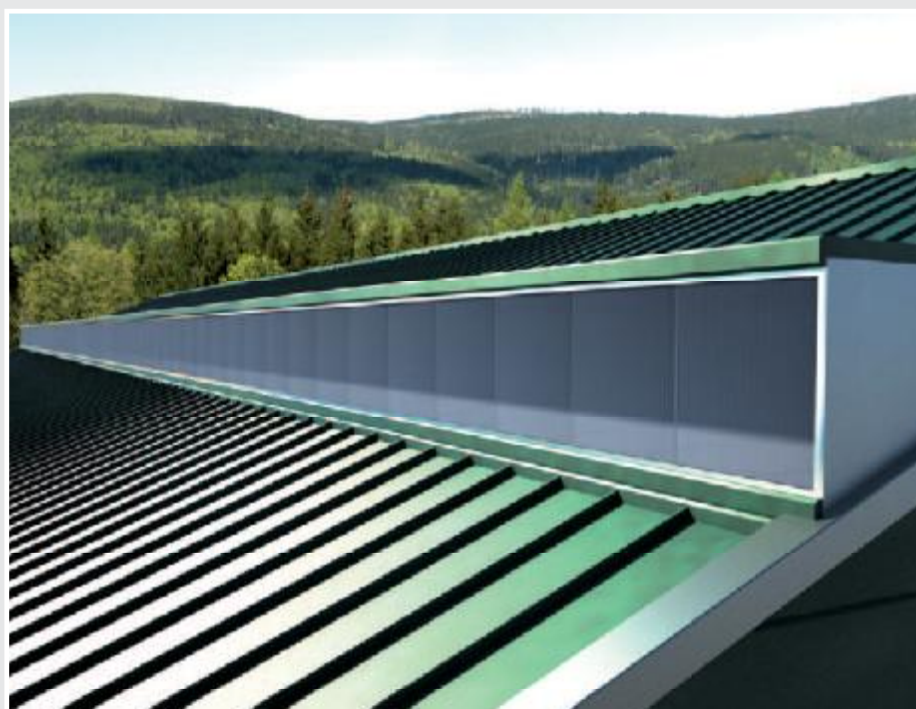

CONTINUOUS WINDOWS
Translucent continuous windows



ACCESSORIES

The system includes a complete range of aluminium profiles for installing the panels. The air cells of the polycarbonate panels must be sealed using vented aluminium breather tape. This allows correct ventilation and prevents soiling on the inside.

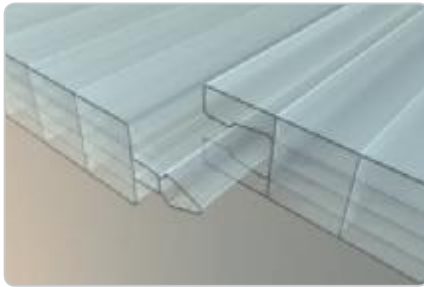

DETAIL JOINT
Detail joint male-female

METAL PROFILES

code 4062
Base AL profile

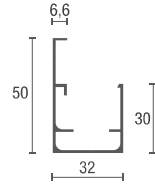

code 4064
Base AL profile with eave

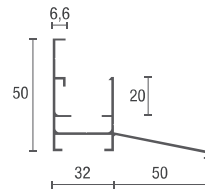

code 4061
Upper and side AL profile

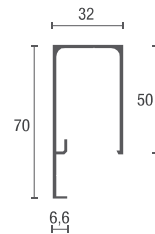

ACCESSORIES



4062
Base AL profile



4064
Base AL profile with eave



4061
Upper and side AL profile



1169/B
Slip Coat Gasket



4327
Additional sealing tape

LOAD RESISTANCE

Maximum loads on two supports

Values below refer to product installed according to the Technical Handbook Recommendation

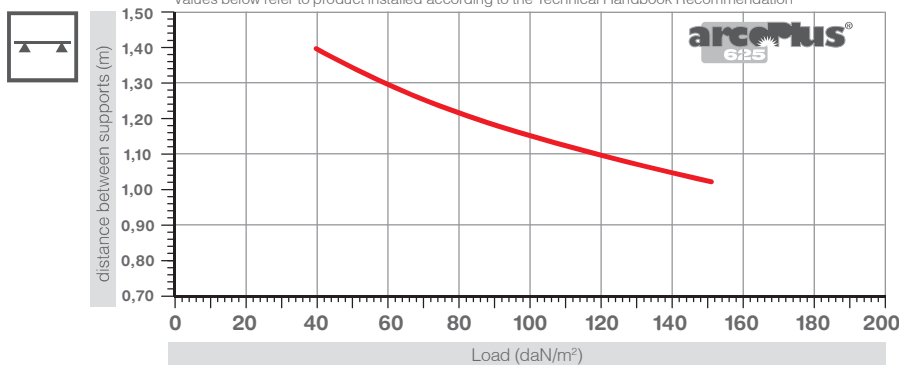

EASY AND LOW-COST INSTALLATION

The 20mm-thick, 5 walls structure with tongue and groove connection gives the panels remarkable flexural strength.

It also allows the panels to be installed without the use of metal reinforcement frames, thus eliminating heat loss due

to the thermal bridges caused by these structures.

The modular connection ensures a watertight seal for glazing with an inclination of up to 30°.

2.1 INTERLOCKING SYSTEMS

arcoPlus®
344x

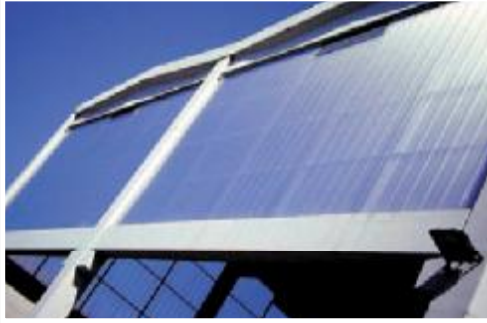

PROFILE

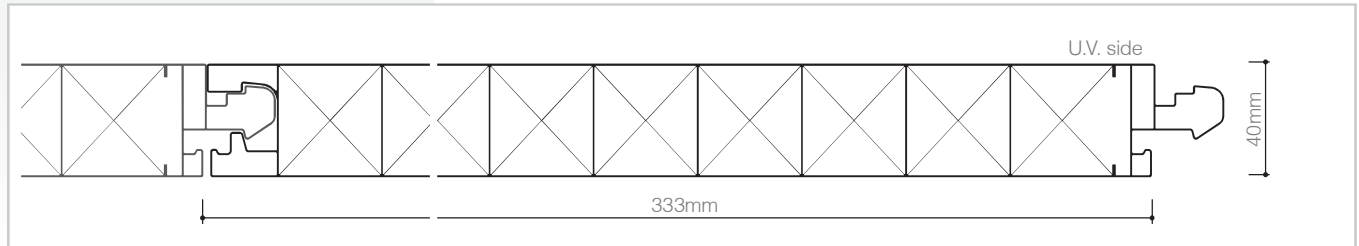

Modular system of multiwall UV protected polycarbonate for windows and translucent roofing applications

PRODUCTION STANDARDS

thickness	40mm
structure	4 walls
effective modular width	333mm
panel length	no limit
colours available	see page 11

TECHNICAL FEATURES

Thermal insulation	1,9 W/m ² K
Acoustic insulation	19 dB
Linear thermal expansion	0,065mm/m°C
Temperature range	-40°C +120 °C
U.V. rays protection	Coextrusion
Fire reaction EN 13501	EuroClass B-s1,d0

DESCRIPTION



arcoPlus®344x is a modular system used in the residential and industrial building sectors. It is suitable for use in new buildings and for renovation and maintenance projects. The system consists of coextruded 4 walls polycarbonate panels with a thickness of 40mm, aluminium profiles, accessories and opening windows, designed for simple and versatile use.

arcoPlus®344x can be used for roofing applications with a minimum slope of 7%.

ADVANTAGES

- ❖ Easy and low-cost installation
- ❖ Light transmission
- ❖ Resistance to U.V. rays and to hail
- ❖ Heat insulation
- ❖ High load resistance

APPLICATIONS

-  Vertical windows
-  Roofing





LOAD RESISTANCE

Maximum loads on two supports

Values below refer to product installed according to the Technical Handbook Recommendation

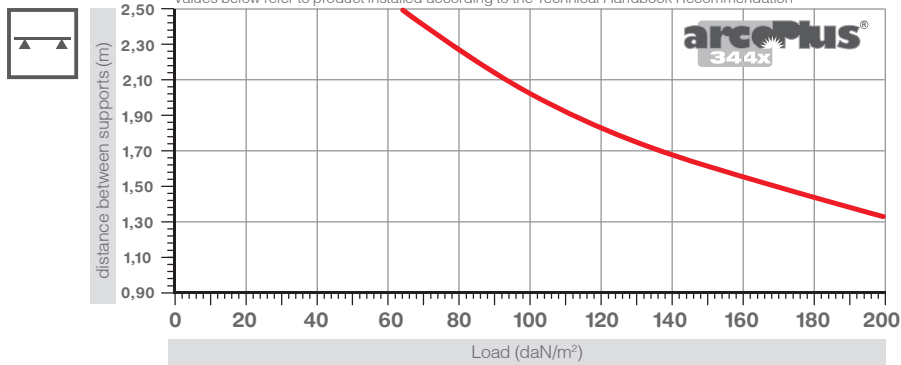

Maximum loads on more supports

Values below refer to product installed according to the Technical Handbook Recommendation

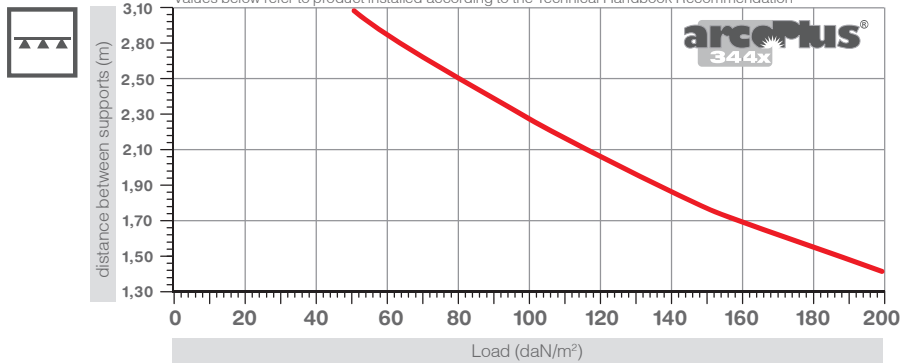

EASY AND LOW-COST INSTALLATION

The 40mm-thick, 4 walls design with tongue and groove connection gives the panels remarkable flexural strength. It also allows the panels to be installed without the use of metal reinforcement frames (continuous windows), thus eliminating heat loss due to the thermal bridges caused by these structures (discontinuous windows).

For installations exceeding 2.2m, a suitable section-breaker profile must be installed to which the arcoPlus® panels can then be fixed.

This is done using the specific brackets to give the system the necessary resistance to negative wind load and permit sliding due to thermal expansion (see load resistance graph).



**CALCULATION AND INSTALLATION
EXAMPLES OF PANEL LENGTH (PL)**



**WITH
EAVE**
 $LP = A - 50 \text{ mm}$
 (base profile without TT)
 $LP = A - 65 \text{ mm}$
 (base profile with TT)
 A = opening measure

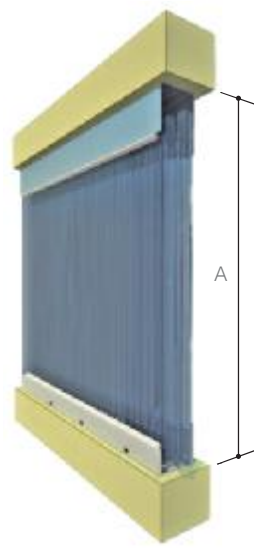

**WITHOUT
EAVE**
 $LP = A - 45 \text{ mm}$
 (base profile without TT)
 $LP = A - 60 \text{ mm}$
 (base profile with TT)
 A = opening measure

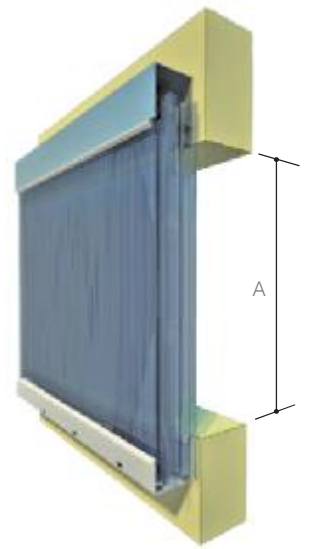

**OUTSIDE OF
THE BUILDING**
 $LP = A + 95 \text{ mm}$
 (profile without TT)
 $LP = A + 60 \text{ mm}$
 (profile with TT)
 A = opening measure

TRANSLUCENT CURTAIN WALLS
 Realization vertical translucent curtain walls



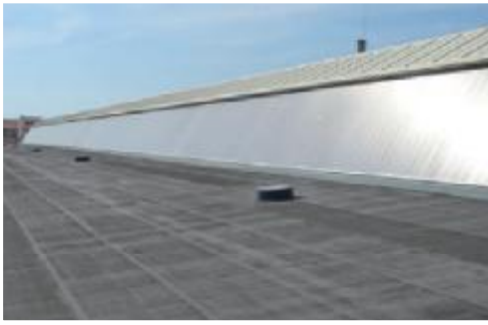

ACCESSORIES

In addition to a complete range of aluminium profiles (also available as thermally insulated) for installing the panels, the system also includes opening windows (manually operated or motorised) to ventilate the building (see opening systems on page 70).

The air cells of the polycarbonate panels must be sealed using vented aluminium breather tape.

This allows correct ventilation and prevents soiling on the inside.



INSERTION OF PLATE

Insertion of aluminium plates for anchorage to existing structures.



BASE PROFILE

Detail of curtain wall, insertion in base profile.

METAL PROFILES

code 4047
Base AL profile

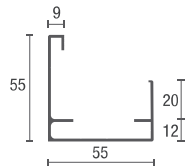

code 4140
Base AL profile with frontal opening

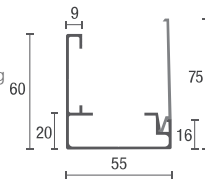

code 4046
Base AL profile with eave

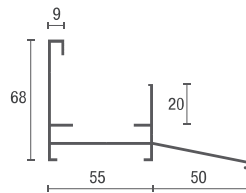

code 4045
Upper and side AL profile

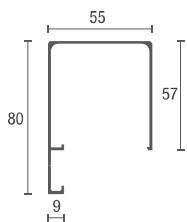

code 4587
Base profile TT in AL

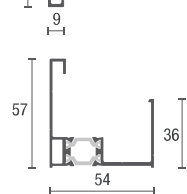

code 4590
Base profile TT with eave in AL

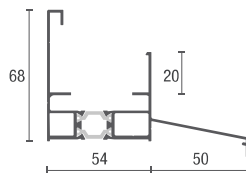

code 4585
Upper and side profile TT in AL

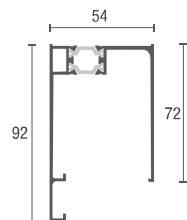

ACCESSORIES



4047
Base AL profile



4046
Base AL profile with eave

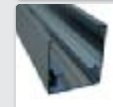

4140
Base AL profile with frontal opening



4045
Upper and side AL profile



4587
Base profile TT in AL



4590
Base profile TT with eave in AL



4585
Upper and side profile TT in AL



4050
Aluminium bracket



4052
Inox bracket



4312
Eclipse



1169/B
Slip Coat Gasket



4108
Additional sealing tape

2.1 INTERLOCKING SYSTEMS

arcoPlus®
347 | 333mm
547 | 500mm



PROFILE

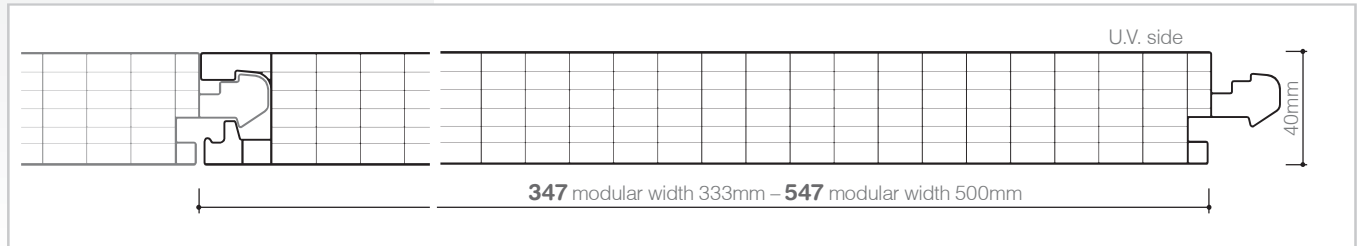

**Modular system of
multiwall UV protected
polycarbonate
for windows and
translucent roofing
applications**



LIGHT MANAGEMENT



PRODUCT AVAILABLE
WITH IR AND AR TREATMENT

PRODUCTION STANDARDS

thickness	40mm
structure	7 walls
modular width	333mm (347)–500mm (547)
panel length	no limit
colours available	see page 11

TECHNICAL FEATURES

Thermal insulation	1,1 W/m ² K
Acoustic insulation	22 dB
Linear thermal expansion	0,065mm/m°C
Temperature range	-40°C +120 °C
U.V. rays protection	Coextrusion
Fire reaction EN 13501	EuroClass B-s1,d0

DESCRIPTION



arcoPlus®547 is a modular system of coextruded 7 walls polycarbonate panels with a thickness of 40mm, aluminium profiles, accessories and opening windows, designed for simple and versatile use.

arcoPlus®547 can be used for roofing applications with a minimum slope of 7%.

ADVANTAGES

- ❖ Easy and low-cost installation
- ❖ Light transmission
- ❖ Resistance to U.V. rays and to hail
- ❖ Heat insulation
- ❖ High load resistance

APPLICATIONS

-  Vertical windows
-  Roofing

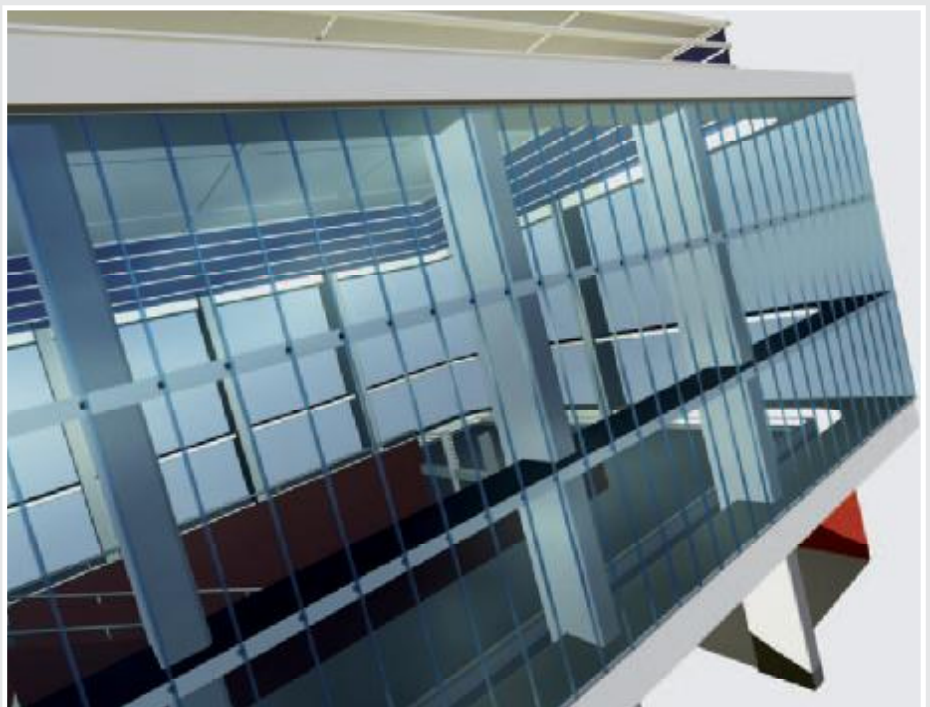



LOAD RESISTANCE

Maximum loads on two supports

Values below refer to product installed according to the Technical Handbook Recommendation

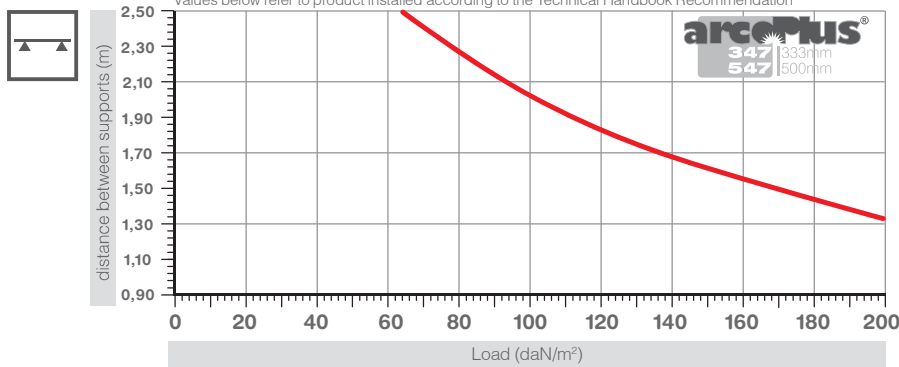

Maximum loads on more supports

Values below refer to product installed according to the Technical Handbook Recommendation

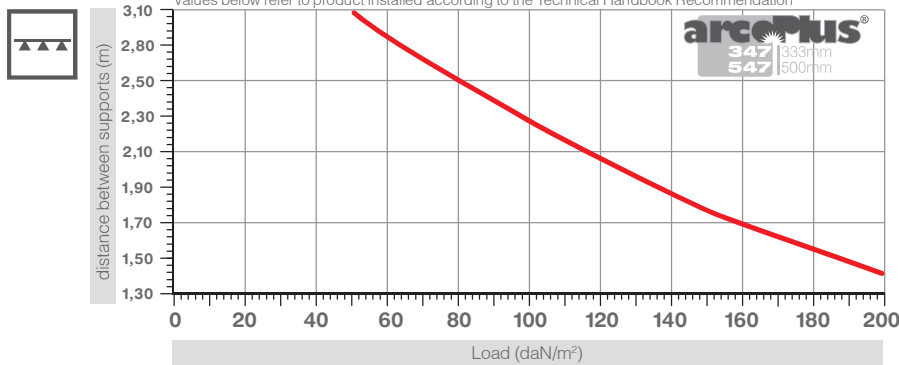

EASY AND LOW-COST INSTALLATION

The 40mm-thick, 7 walls design with tongue and groove connection gives the panels remarkable flexural strength. It also allows the panels to be installed without the use of metal reinforcement frames (continuous glazing), thus eliminating heat loss due to the thermal bridges caused by these structures (discontinuous glazing).

For installations exceeding 2.2m, a suitable section-breaker profile must be installed to which the arcoPlus® panels can then be fixed. This is done using the specific brackets to give the system the necessary resistance to negative wind load and permit sliding due to thermal expansion (see load resistance graph).



INSERTION OF PLATE
Insertion of aluminium plates for anchorage to existing structures.



**CALCULATION AND INSTALLATION
EXAMPLES OF PANEL LENGTH (PL)**



**WITH
EAVE**

LP = A - 50 mm
(base profile without TT)
LP = A - 65 mm
(base profile with TT)
A = opening measure

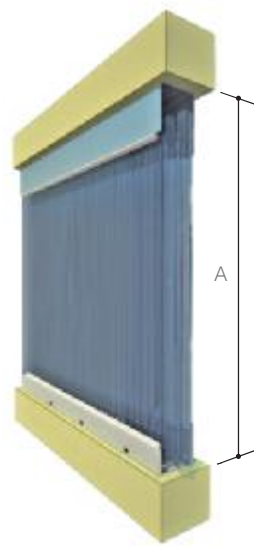

**WITHOUT
EAVE**

LP = A - 45 mm
(base profile without TT)
LP = A - 60 mm
(base profile with TT)
A = opening measure

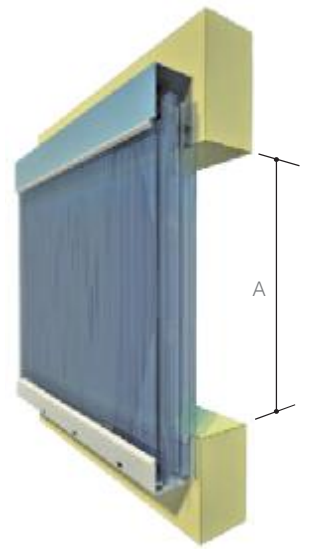

**OUTSIDE OF
THE BUILDING**

LP = A + 95 mm
A = opening measure



TRANSLUCENT CURTAIN WALLS
Realization vertical translucent curtain walls



ACCESSORIES

In addition to a complete range of aluminium profiles (also available as thermally insulated) for installing the panels, the system also includes opening windows (manually operated or motorised) to ventilate the building (see opening systems on page 70).

The air cells of the polycarbonate panels must be sealed using vented aluminium breather tape.

This allows correct ventilation and prevents soiling on the inside.



SIDE PROFILE
Detail side profile TT in AL



BASE PROFILE WITH TT
Detail base profile TT with eave in AL

METAL PROFILES

code 4047
Base AL profile

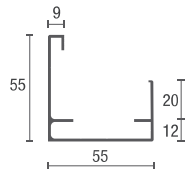

code 4140
Base AL profile
with frontal opening

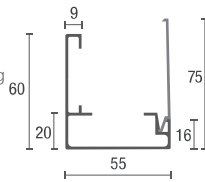

code 4046
Base AL profile
with eave

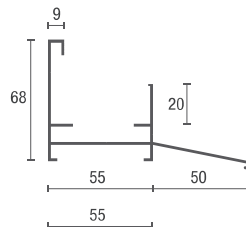

code 4045
Upper and side
AL profile

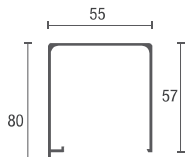

code 4587
Base profile TT
in AL

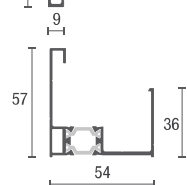

code 4590
Base profile TT
with eave in AL

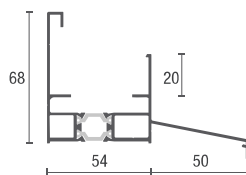

code 4585
Upper and side
profile TT in AL

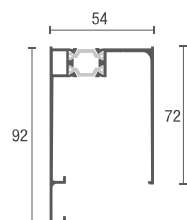

ACCESSORIES



4047
Base AL profile



4046
Base AL profile
with eave



4140
Base AL profile
with frontal opening



4045
Upper and side
AL profile



4587
Base profile TT
in AL



4590
Base profile TT
with eave in AL



4585
Upper and side profile
TT in AL



4050
Aluminium bracket



4052
Inox bracket



4312
Eclipse



1169/B
Slip Coat Gasket



4108
Additional sealing tape

2.1 INTERLOCKING SYSTEMS

Velario®
613 | 10mm
20-5 | 20mm

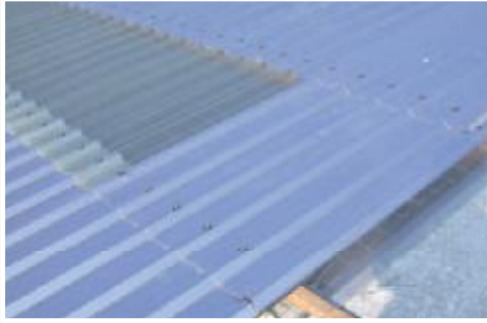

PROFILE

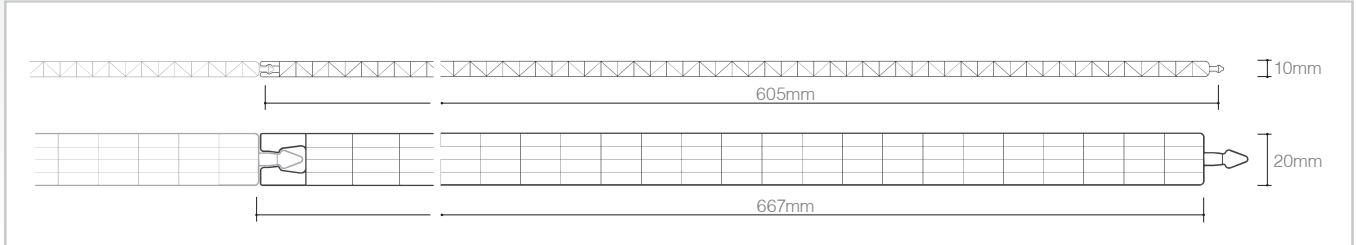

Modular system
of multiwall
polycarbonate for
false ceilings
and partitions
**WITHOUT UV
PROTECTION**

PRODUCTION STANDARDS

	Velario®613	Velario®20-5
thickness	10mm	20mm
structure	3 walls	5 walls
effective modular width	605mm	667mm
panel length	no limit	no limit



TECHNICAL FEATURES

	Velario®613	Velario®20-5
Thermal insulation	2,7 W/m ² K	1,7 W/m ² K
Acoustic insulation	16 dB	16 dB
Linear thermal expansion	0,065mm/m°C	0,065mm/m°C
Temperature range	-40°C +120 °C	-40°C +120 °C
Fire reaction EN 13501	EuroClass B-s1,d0	EuroClass B-s1,d0

ADVANTAGES

- ❖ Easy and low-cost installation
- ❖ Light transmission
- ❖ Heat insulation
- ❖ Self-supporting

APPLICATIONS

-  Room partitions
-  False ceilings

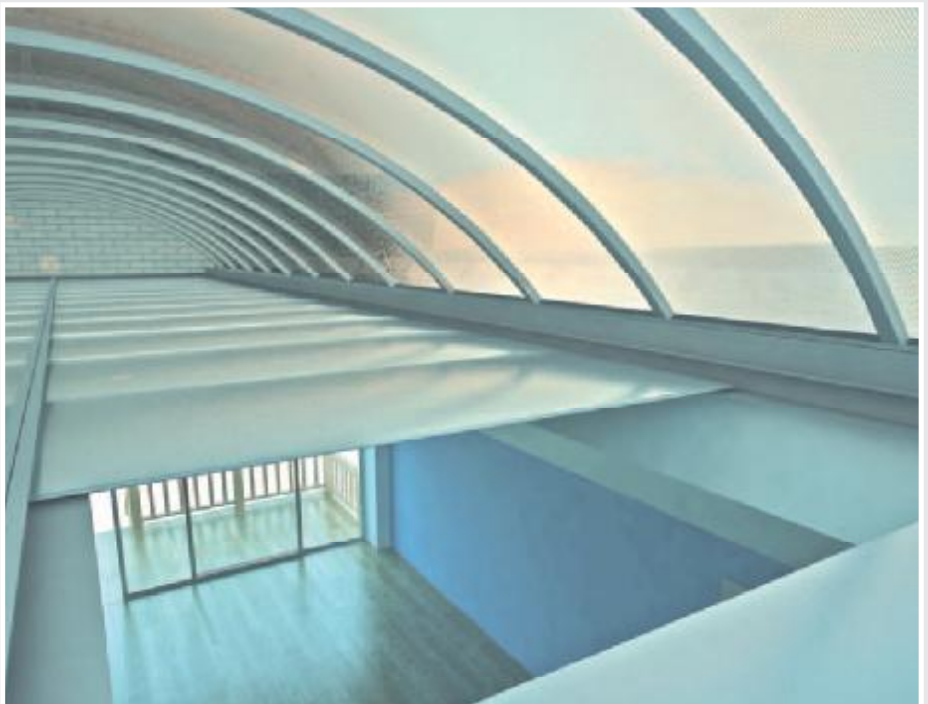



DESCRIPTION

Velario®613 and Velario®20-5, are modular systems used in residential and industrial buildings, for new buildings as well as for renovation and maintenance operations. It consists of polycarbonate panels

with male-female connection. They are ideal for all those cases where a thermal insulation is required with a rapid and simple installation.

LOAD RESISTANCE

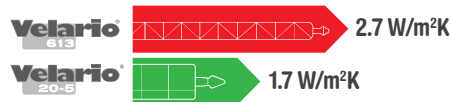
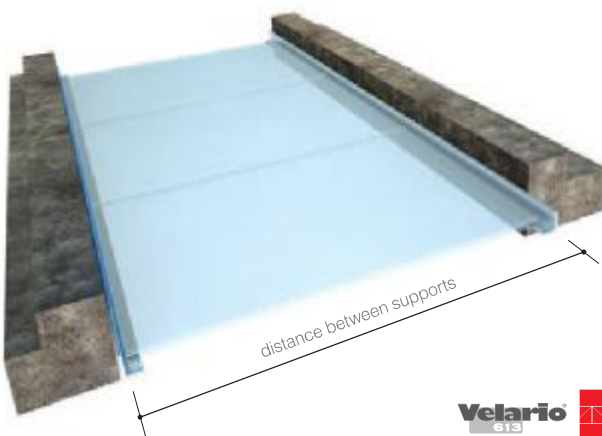
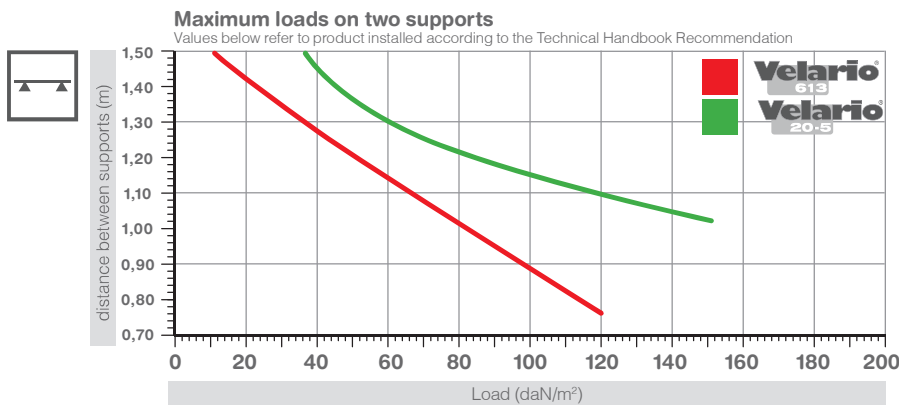

THE CHOICE OF PROFILE

The indicated diagram shows the maximum recommended distance based on the type of profile used. The choice of the system to be used is therefore in function of the distance between the support and the value of insulation requested.

To avoid soiling the inside of the cells, it is recommended to request the product taped or thermowelded at the ends.

ACCESSORIES

code 4226
Thermowelding

cod. 4073 (Velario613)
Aluminium tape.

cod. 4327 (Velario20-5)
Aluminium tape.



VELARIO
Detail Velario metal roofing

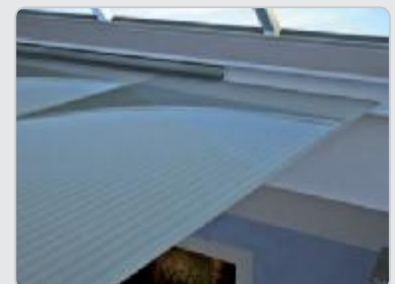

FALSE CEILING
detail anchorage panels

arcoplus®
613

Modular system of
UV protected
multiwall
polycarbonate for
vertical window
applications

2.2 MODULAR CONNECTOR SYSTEMS

arcoPlus®
684 | 8mm
6104 | 10mm
6124 | 12mm



PROFILE

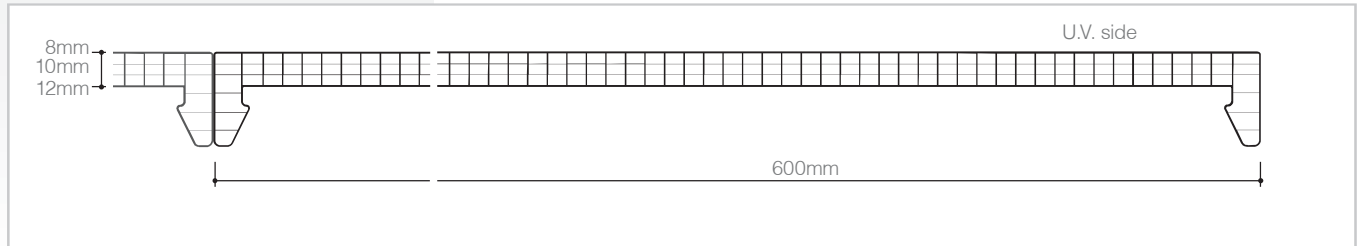

**Modular system of
UV protected
multiwall
polycarbonate for
translucent curtain
walls and roofing
applications**



LIGHT MANAGEMENT



PRODUCT AVAILABLE
WITH IR AND AR TREATMENT

PRODUCTION STANDARDS

thickness	8-10-12mm
structure	4 walls
effective modular width	600mm
panel length	no limit
colours available	see page 11

TECHNICAL FEATURES

Thermal insulation	3,3 - 3,0 - 2,7 W/m²K
Acoustic insulation	18 dB (th.8-10mm) 19dB (th.12mm)
Linear thermal expansion	0,065mm/m°C
Temperature range	-40°C +120 °C
U.V. rays protection	Coextrusion
Fire reaction EN 13501	EuroClass B-s1,d0

DESCRIPTION



arcoPlus®684-6104-6124 are three modular systems consisting of co-extruded 4 walls polycarbonate panels with thicknesses of 8-10 and 12mm, inserted in plastic-coated steel or aluminium profiles using a click-on system.

Used for vertical windows, flat roofing (min. slope 5%) and curved roofing (minimum radius 2.0m).

ADVANTAGES

- ❖ Easy and low-cost installation
- ❖ Light transmission
- ❖ Resistance to U.V. rays and to hail
- ❖ Heat insulation
- ❖ Self-supporting

APPLICATIONS

-  Vertical windows
-  Roofing
-  Curved roofing



CONTINUOUS ROOFING

Model of tunnel with
reinforced aluminium profil



LOAD RESISTANCE



Maximum loads on two supports

Values below refer to product installed according to the Technical Handbook Recommendation

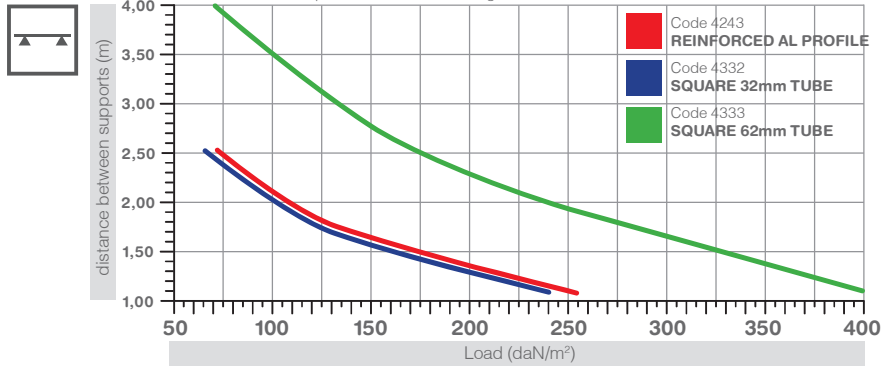

Maximum loads on more supports

Values below refer to product installed according to the Technical Handbook Recommendation

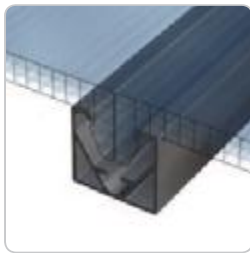
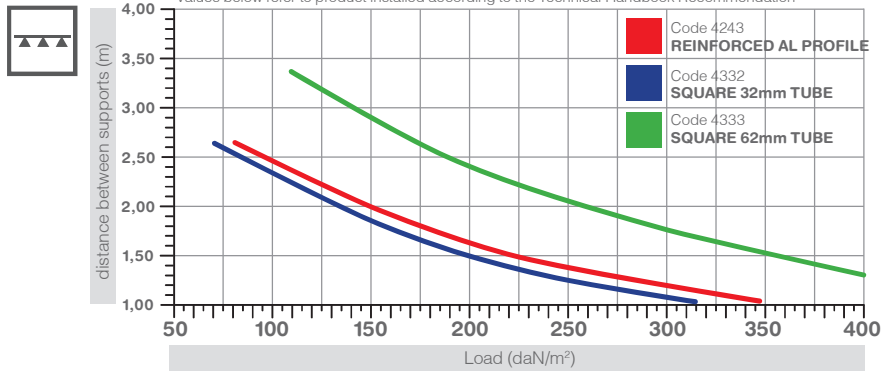

SYSTEM WITH REINFORCED ALUMINIUM PROFILE



SYSTEM WITH SQUARE 32mm TUBE

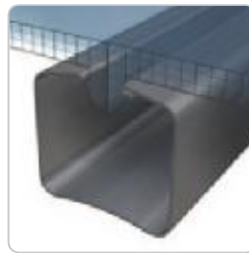

SYSTEM WITH SQUARE 62mm TUBE

FLAT SELF-SUPPORTING SYSTEM

The arcoPlus®684-6104-6124 systems can be used for vertical walls and flat roofing applications. The panels are inserted on open joint metal tubes using a click-on system. This ensures

the necessary wind and snow load resistance properties (see load resistance tables).

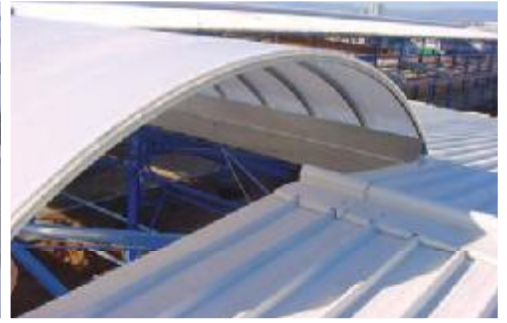

CURVED SYSTEM LOAD RESISTANCE



Maximum loads on two supports R.4.000mm

Values below refer to product installed according to the Technical Handbook Recommendation

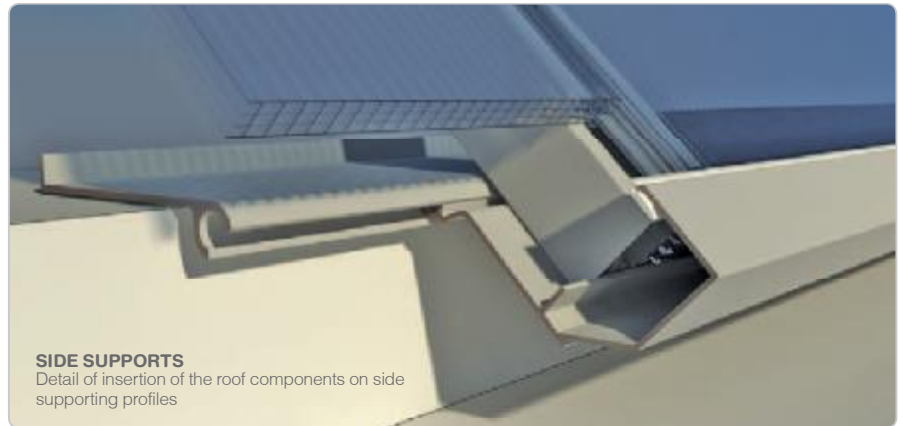
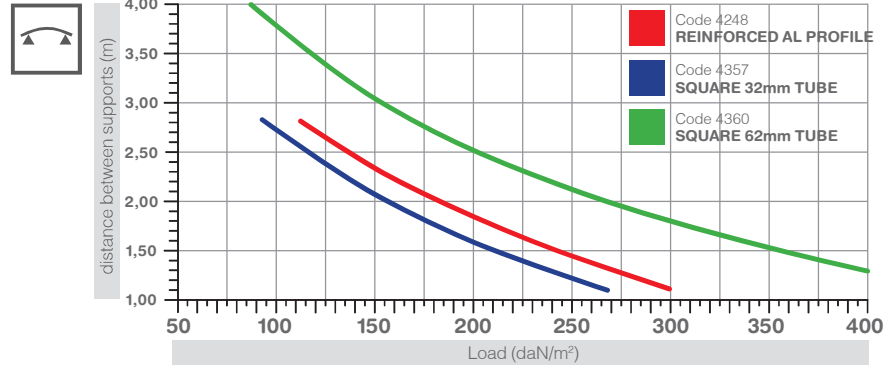

CURVED SELF-SUPPORTING SYSTEM

The metal reinforcement frames guarantee the load capacity of the entire system, while the polycarbonate staves create a continuous curtain walling effect. Special adjustable supports guarantee a complete seal.

Different types of reinforcement frames are available to guarantee the required load and wind resistance properties according to the relative load resistance values and conditions of use. Minimum bend radius R.2.000mm

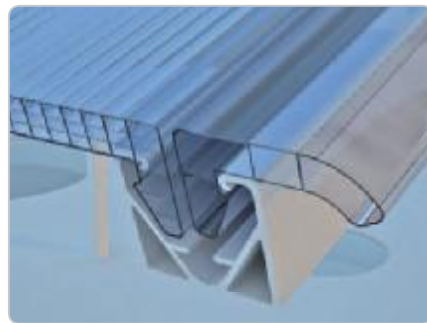

START PROFILE
Detail of insertion of start profile on roof.



END PROFILE
Detail of insertion of section-breaker profile to complete roofing.

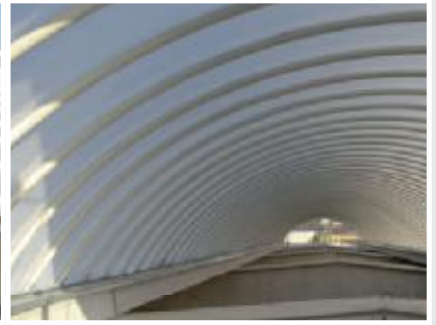

EASY AND LOW-COST INSTALLATION

The 4 walls design with click-on connection to open joint tubes gives the panel remarkable flexural strength and is suitable for creating vertical walls and large areas of self-supporting roofing without the use of section-breaker profiles.

ACCESSORIES

arcoPlus® includes a complete range of accessories that guarantee a perfectly watertight seal and significant wind load resistance.

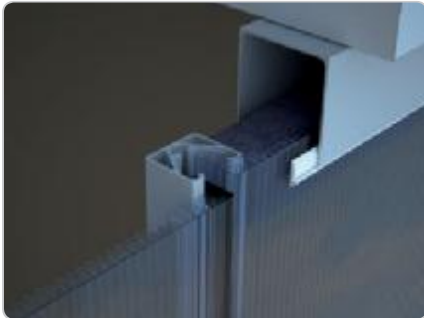

DETAIL OF UPPER PROFILE
Upper profile with gasket and sealing pad.

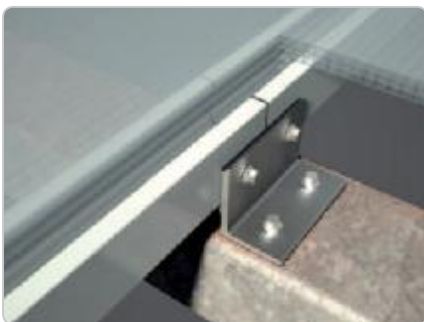

DETAIL FIXING OF ECLYPSE
Detail of the union of the profiles in aluminium with eclipse in aluminium



DETAIL OF BASE
Insertion of curtain wall profiles on removable base with front panel.

METAL PROFILES

code 4140
Base AL profile
with frontal opening

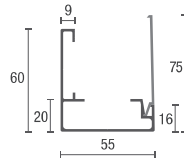

code 4045
Upper and side
AL profile

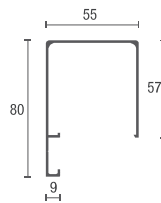

code 4243 (straight)
code 4248 (curved)
Reinforced AL profile

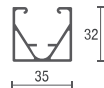

code 4244 (straight)
code 4249 (curved)
Gabled AL profile

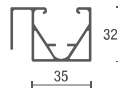

code 4332 (straight)
code 4357 (curved)
Square 32mm tube



code 4333 (straight)
code 4360 (curved)
Square 62mm tube

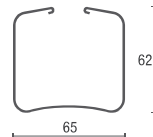

code 4245
U-shaped closing
support in AL

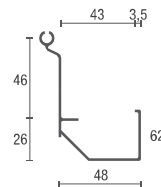

code 4252
closing
support in AL

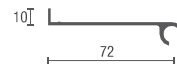

code 4260
Eclipse

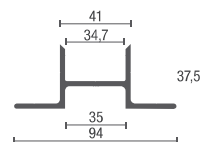

 **4665/600** th.8mm
4666/600 th.10mm
4667/600 th.12mm
Block cover AL profile

ACCESSORIES



4140
Base AL profile
with frontal opening



4045
Upper and side
AL profile



4243 (straight)
4248 (curved)
Reinforced AL profile



4244 (straight)
4249 (curved)
Gabled AL profile



4332 (straight)
4357 (curved)
Square 32mm tube

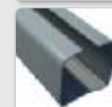

4333 (straight)
4360 (curved)
Square 62mm tube



4245
U-shaped closing
support in AL



4252
closing
support in AL



4589
Profilo terminale
in AL



2147
Start profile 684-6104
in polycarbonate
th.8/10mm



2245
Start profile 6124
in polycarbonate
th.12mm



2148 th.8mm
2265 th.10mm
2250 th.12mm
End profile in PC



4213 dim. 40x35x580
4221 dim. 70x40x580
Pad PE-LD



4260
Eclipse

2.2 MODULAR CONNECTOR SYSTEMS

arcoPlus®
Reverso 684|6104|6124
8mm 10mm 12mm



PROFILE

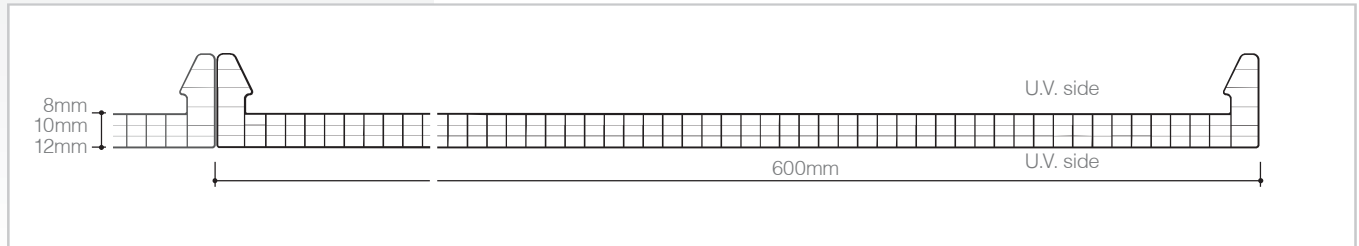

Modular system of bi-protected multiwall polycarbonate for translucent roofing applications



LIGHT MANAGEMENT



PRODUCT AVAILABLE
WITH IR AND AR TREATMENT

PRODUCTION STANDARDS

thickness	8-10-12mm
structure	4 walls
effective modular width	600mm
panel length	no limit
colours available	see page 11

TECHNICAL FEATURES

Thermal insulation	3,3 - 3,0 - 2,7 W/m²K
Acoustic insulation	18 dB (th.8-10mm) 19dB (th.12mm)
Linear thermal expansion	0,065mm/m°C
Temperature range	-40°C +120 °C
U.V. rays protection	2 sides Coextrusion
Fire reaction EN 13501	EuroClass B-s1,d0

DESCRIPTION

arcoPlus®684-6104-6124 reversò are three modular systems consisting of 4 walls polycarbonate panels with UV protection on two sides and thicknesses of 8-10-12mm. They are anchored to the existing structures using specific anchor brackets. The panels are joined together using a protected polycarbonate or aluminium cover plate profile assembled using a click-on system to guarantee a perfectly watertight seal.

ADVANTAGES

- ❖ Easy and low-cost installation
- ❖ Light transmission
- ❖ Resistance to U.V. rays and to hail
- ❖ Heat insulation
- ❖ Bendability R.min=2,5m

APPLICATIONS

 Roofing

 Curved roofing



CONTINUOUS ROOFING
Example of roofing with polycarbonate cover plate.



LOAD RESISTANCE

Maximum loads on two supports

Values below refer to product installed according to the Technical Handbook Recommendation

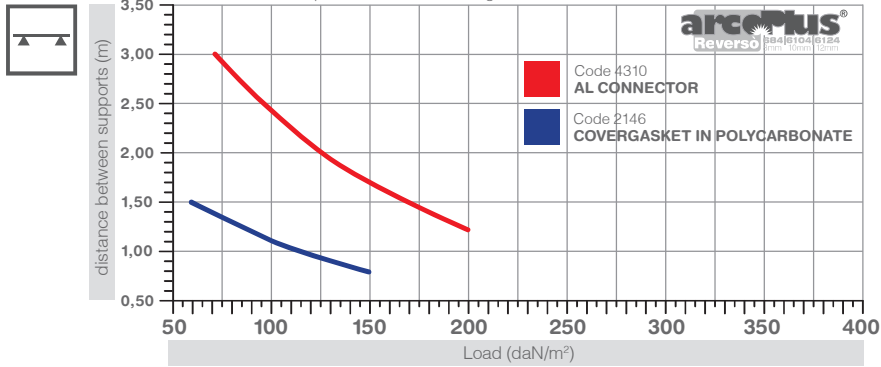

Maximum loads on more supports

Values below refer to product installed according to the Technical Handbook Recommendation

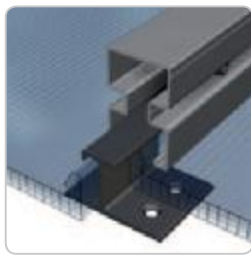
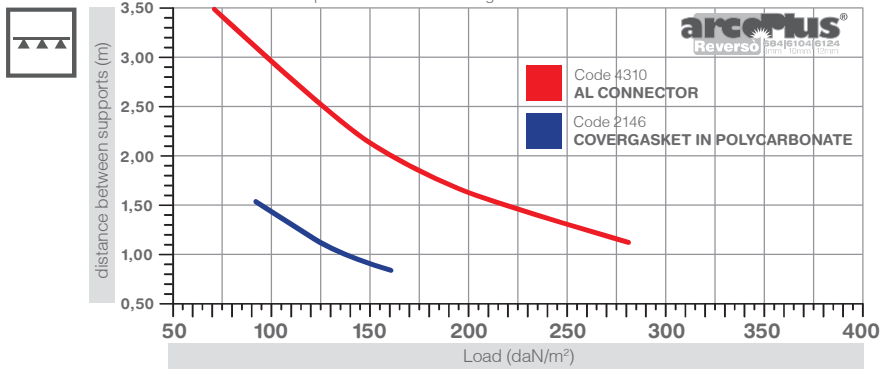

SYSTEM WITH ALUMINIUM CONNECTOR CODE 4310

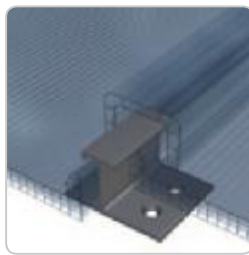

SYSTEM WITH POLYCARBONATE COVERGASKET - CODE2146

EASY AND LOW-COST INSTALLATION

To ensure compliance with snow load and negative wind load resistance requirements, anchor brackets should be fitted for each purlin.

The polycarbonate panels are fastened to the underlying structure using specific brackets, which must be anchored to the purlins using suitable self-drilling/self-tapping screws (on metal structures) and tap bolts (for

wooden structures). These screws and bolts are not supplied.

Different connector profiles can be used, depending on the required load specifications.



COMPLETE SYSTEM FOR ROOFING

The modular polycarbonate panels can be used to create flat or curved roofing. They are fixed to the supporting structures using specific aluminium brackets.

Depending on the load capacity values required, or the distance between

the purlins of the underlying structures, either polycarbonate cover plates can be used or, for greater strength, aluminium connectors.

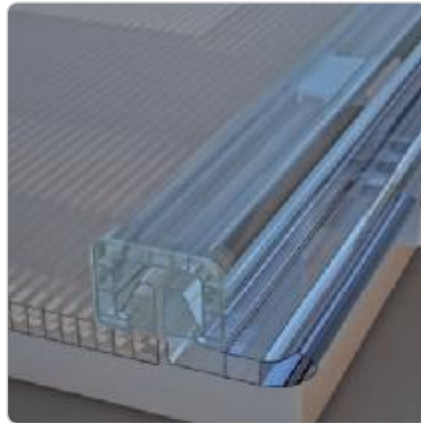

START PROFILE
Detail of insertion of start profile on roof.



END PROFILE
Detail of insertion of section-breaker profile to complete roofing.

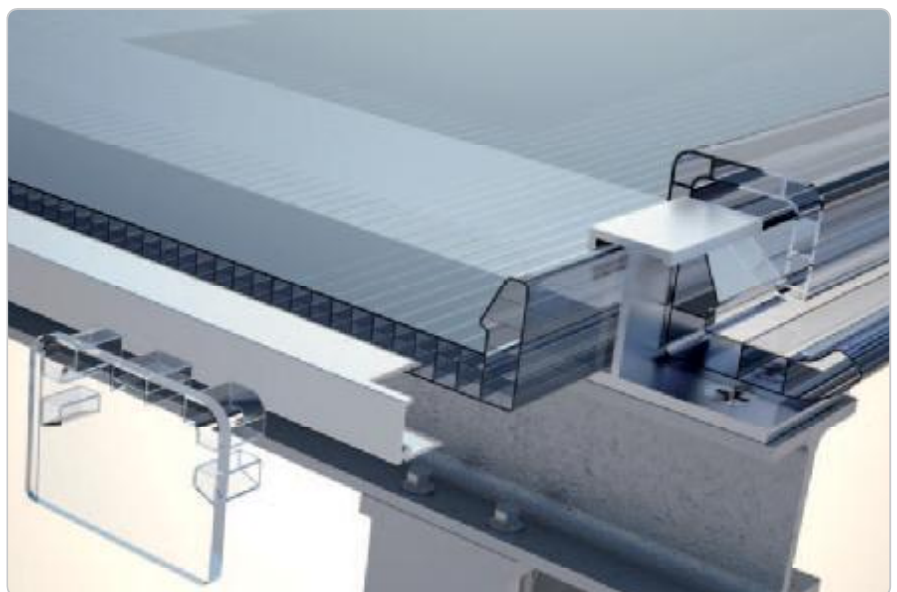

DETAIL OF COMPLETE SYSTEM
Start profile with panel, cover plate, plate and air cell cover profiles.



ACCESSORIES

The arcoPlus® system includes a complete range of accessories to facilitate installation. For correct installation the ends of the air cells in the panels must be heat-sealed to prevent soiling on the inside.

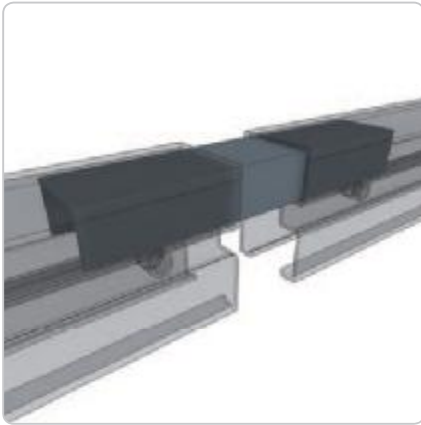

CONNECTOR JOINT
AL connector profiles with eclipse.

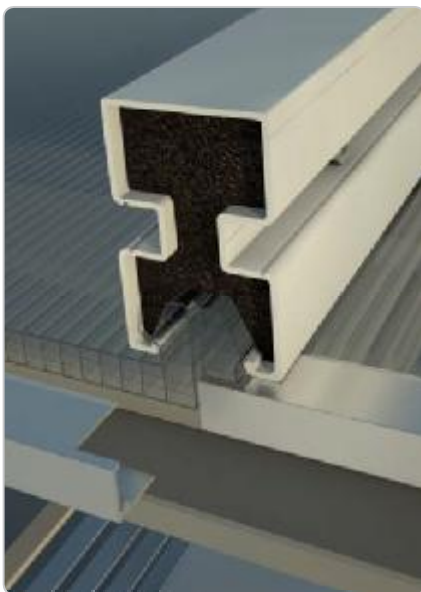

DETAIL OF CONNECTOR
Use of aluminium joint screwed down and end closed with PE-LD pad.

METAL PROFILES

code 4310
Connector AL
profile with screw

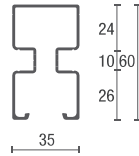

code 4245
U-shaped closing
support in AL

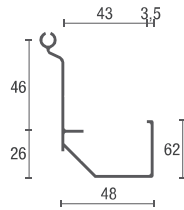

code 4252
Closing
support in AL



4213 dim. 40x35x580
4221 dim. 70x40x580
Pad PE-LD



4318
Pad PE-LD
for connector



4329
Sealing tape PE-LD
4x15mm



4316 M6 nut
4315 M6 x 20 screw
Accessories for connector

ACCESSORIES



4303
Covergasket
stopper



2146
Covergasket
in polycarbonate



2282
Double connector
in polycarbonate



2147
Start profile 684-6104
in polycarbonate



2245
Start profile 6124
in polycarbonate



2148 th.8mm
2265 th.10mm
2250 th.12mm
End profile in PC



4310
Connector AL
profile with screw



4245
U-shaped closing
support in AL



4252
closing
support in AL



4319/200
AL eclipse
for connector



4326 th.8mm
4350 th.10mm
4355 th.12mm
AL plate



4264
Stainless steel plate
for vertical connection



4138
Stainless steel plate
for flat connection
(th.8mm)



4675/600 th.8mm
4676/600 th.10mm
4677/600 th.12mm
Block cover AL profile

2.2 MODULAR CONNECTOR SYSTEMS

arcoPlus®
626



PROFILE

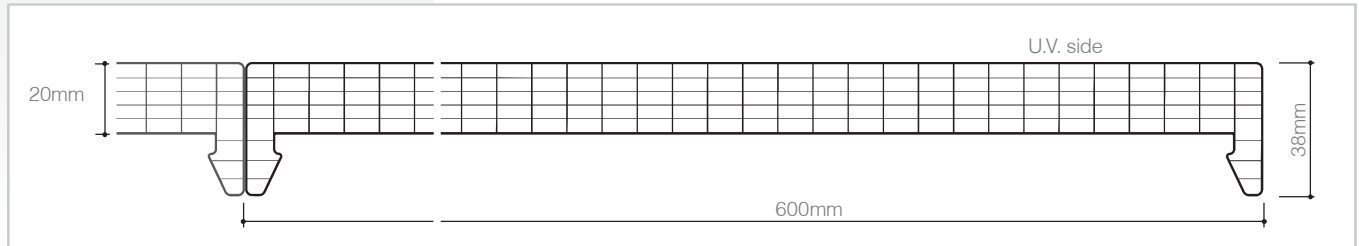

Modular system of UV protected multiwall polycarbonate for translucent curtain walls and roofing



LIGHT MANAGEMENT



PRODUCT AVAILABLE
WITH IR AND AR TREATMENT

PRODUCTION STANDARDS

thickness	20mm
structure	6 walls
effective modular width	600mm
panel length	no limit
colours available	see page 11

TECHNICAL FEATURES

Thermal insulation	1,7 W/m ² K
Acoustic insulation	20 dB
Linear thermal expansion	0,065mm/m°C
Temperature range	-40°C +120 °C
U.V. rays protection	Coextrusion
Fire reaction EN 13501	EuroClass B-s1,d0

DESCRIPTION



arcoPlus®626 is a modular system of co-extruded 6 walls polycarbonate panels with a thickness of 20mm, and 600mm module, assembled using a click-on system to plastic-coated steel or aluminium profiles.

Used for vertical glazing, flat roofing (min. slope 5%) and curved roofing (minimum radius 4m).

ADVANTAGES

- ❖ Easy and low-cost installation
- ❖ Light transmission
- ❖ Resistance to U.V. rays and to hail
- ❖ Heat insulation
- ❖ Self-supporting

APPLICATIONS

-  Vertical windows
-  Roofing
-  Curved roofing





LOAD RESISTANCE

Maximum loads on two supports

Values below refer to product installed according to the Technical Handbook Recommendation

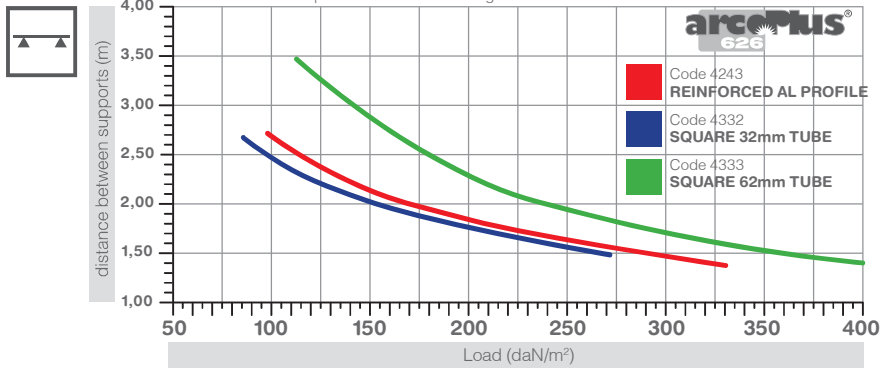

Maximum loads on more supports

Values below refer to product installed according to the Technical Handbook Recommendation

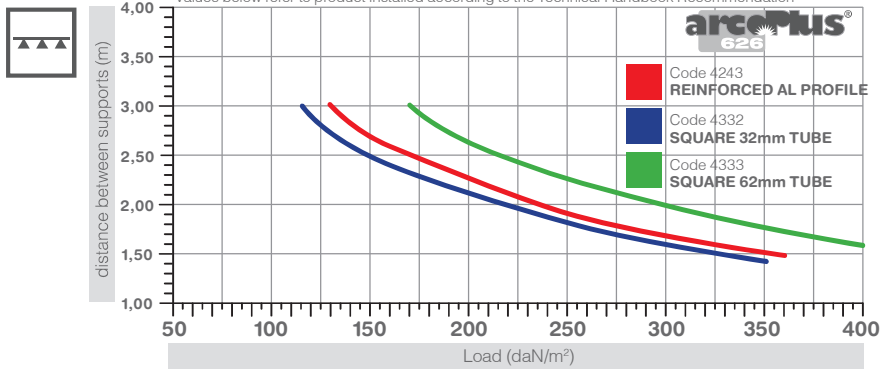

SYSTEM WITH REINFORCED ALUMINIUM PROFILE

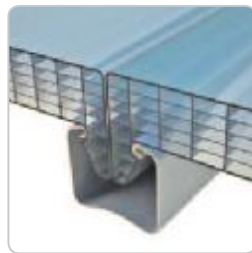

SYSTEM WITH SQUARE 32mm TUBE



SYSTEM WITH SQUARE 62mm TUBE

EASY AND LOW-COST INSTALLATION

The 6 walls design with snap-on connection to open joint tubes gives the panel remarkable flexural strength. It is suitable for vertical curtain walls and large areas of self-supporting roofing without the use of section-breaker profiles.

The snap-on connection and complete range of accessories and alu-

minium perimeter profiles combine to guarantee a perfectly watertight seal and considerable wind load resistance.



CURVED SYSTEM LOAD RESISTANCE

Maximum loads on two supports R.4.000mm

Values below refer to product installed according to the Technical Handbook Recommendation

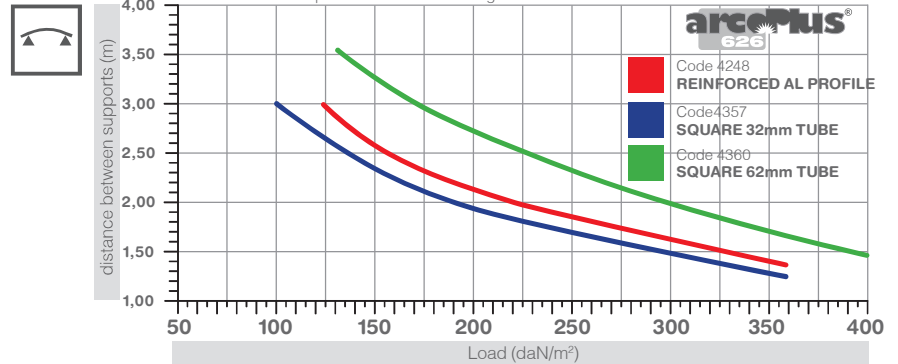

CURVED SELF-SUPPORTING SYSTEM

The metal reinforcement frames guarantee the load capacity of the entire system, while the polycarbonate staves create a continuous curtain walling effect.

Special adjustable supports guarantee a complete seal. Different types of

reinforcement frames are available to guarantee the required load and wind resistance properties according to the relative load capacity values and conditions of use.

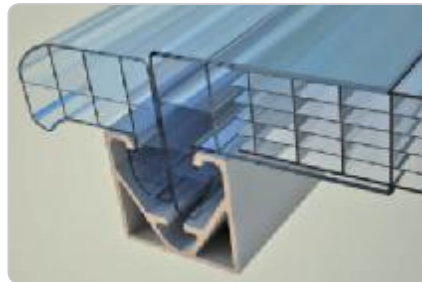

END PROFILE

Detail of insertion of section-breaker profile to complete roofing.

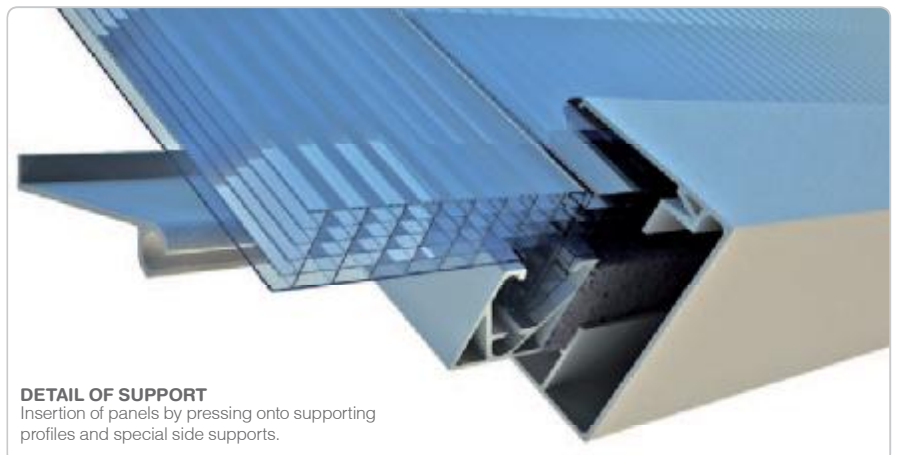
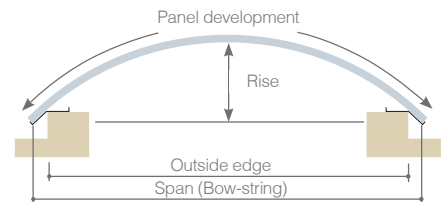

DETAIL OF SUPPORT

Insertion of panels by pressing onto supporting profiles and special side supports.

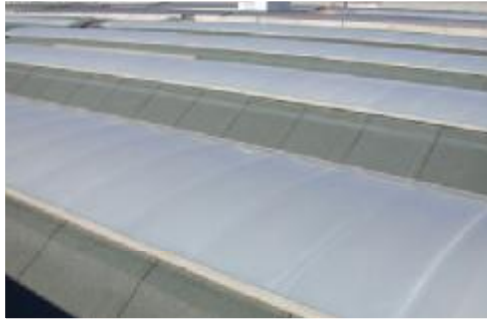

ACCESSORIES

The arcoPlus® system includes a complete range of accessories to facilitate installation.

The air cells of the panels must be sealed using a specific polycarbonate profile or vented aluminium breather tape.

This allows correct ventilation and prevents soiling on the inside.

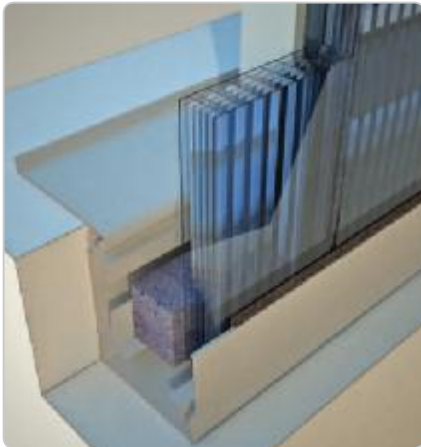

WALL SYSTEM

Construction of continuous transparent walls, with insertion on aluminium profile using a snap-on system.

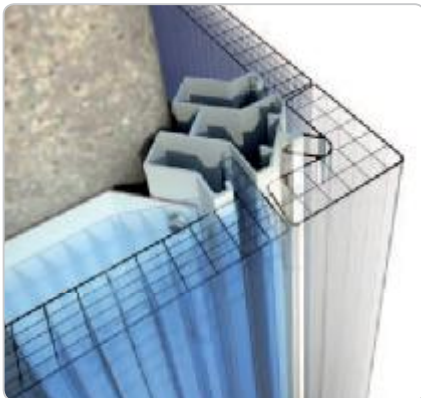

DETAIL CORNER

Click insertion of corner profiles in polycarbonate with aluminium profile

METAL PROFILES

code 4243 (straight)
code 4248 (curved)
Reinforced AL profile

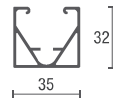

code 4244 (straight)
code 4249 (curved)
Gabled AL profile

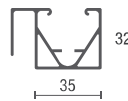

code 4332 (straight)
code 4357 (curved)
Square 32mm tube

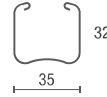

code 4333 (straight)
code 4360 (curved)
Square 62mm tube

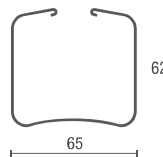

code 4271
Base-side AL profile
with frontal opening

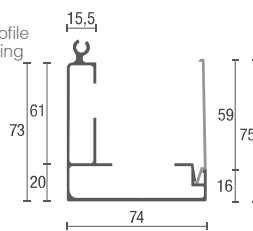

code 4252
closing
support in AL



code 4260
Eclipse for
connector 32mm

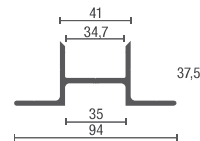

4260
Eclipse for connector 32mm



4668/600 th.20mm
Block cover AL 20

ACCESSORIES



4243 (straight)
4248 (curved)
Reinforced AL profile



4244 (straight)
4249 (curved)
Gabled AL profile



4332 (straight)
4357 (curved)
Square 32mm tube

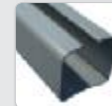

4333 (straight)
4360 (curved)
Square 62mm tube



4271
Base-side AL profile
with frontal opening



4252
Closing
support in AL



4588
Corner profile in
AL

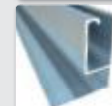

4589
End profile
in AL



2179
Start profile
in polycarbonate



2180
End profile
in polycarbonate



2550
Corner profile
in AL



2182
Block cover



4213 dim. 40x35x580
4221 dim. 70x40x580
Pad PE-LD



4327
Additional tape

2.2 MODULAR CONNECTOR SYSTEMS

arcoPlus®
Reverso 626



PROFILE

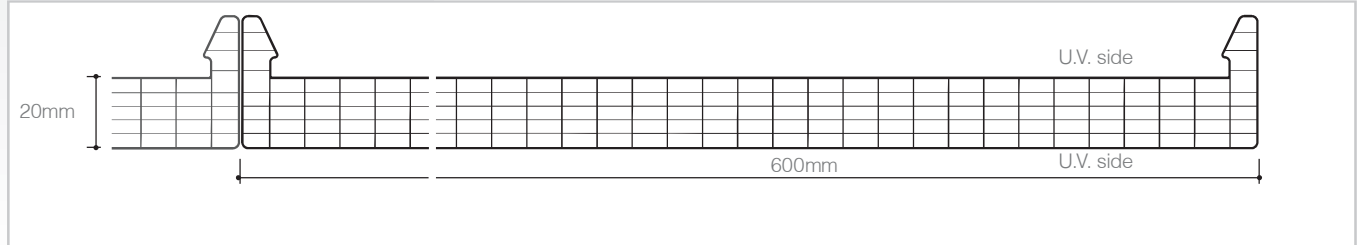

Modular system of bi-protected multiwall polycarbonate for translucent roofing applications

caleido

LIGHT MANAGEMENT



PRODUCT AVAILABLE
WITH IR AND AR TREATMENT

PRODUCTION STANDARDS

thickness	20mm
structure	6 walls
effective modular width	600mm
panel length	no limit
colours available	see page 11

TECHNICAL FEATURES

Thermal insulation	1,7 W/m ² K
Acoustic insulation	20 dB
Linear thermal expansion	0,065mm/m°C
Temperature range	-40°C +120 °C
U.V. rays protection	2 sides Coextrusion
Fire reaction EN 13501	EuroClass B-s1,d0

DESCRIPTION



arcoPlus®626 reversò is a modular system of coextruded six-wall polycarbonate panels with a thickness of 20mm.

These are fixed to the existing structure using specific anchor brackets. The panels are joined together by a protected polycarbonate cover plate assembled using a click-on system, or by an aluminium connector, for a perfectly watertight seal.

ADVANTAGES

- ❖ Easy and low-cost installation
- ❖ Light transmission
- ❖ Resistance to U.V. rays and to hail
- ❖ Heat insulation
- ❖ Bendability R.min=2,5m

APPLICATIONS

-  Roofing
-  Curved roofing
-  Bardages verticaux

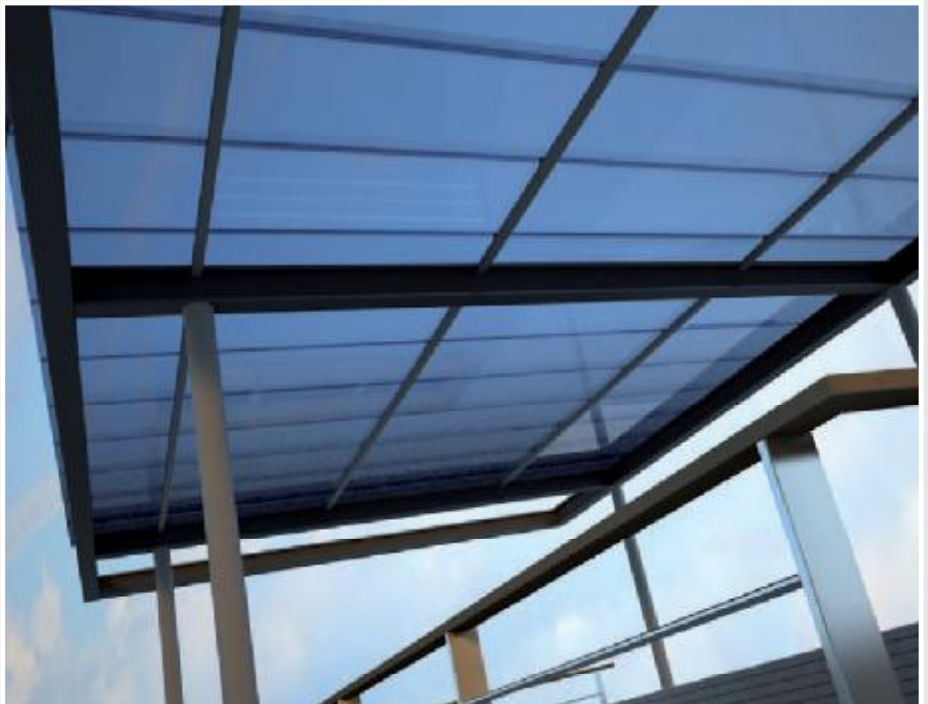



FLAT SYSTEM LOAD RESISTANCE

Maximum loads on two supports

Values below refer to product installed according to the Technical Handbook Recommendation

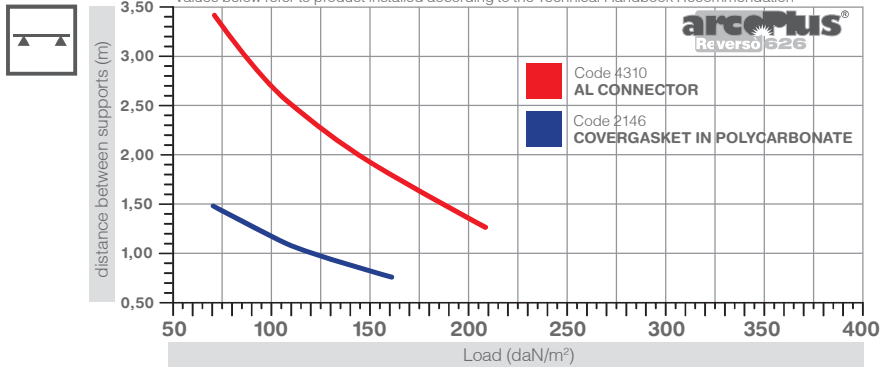

Maximum loads on more supports

Values below refer to product installed according to the Technical Handbook Recommendation

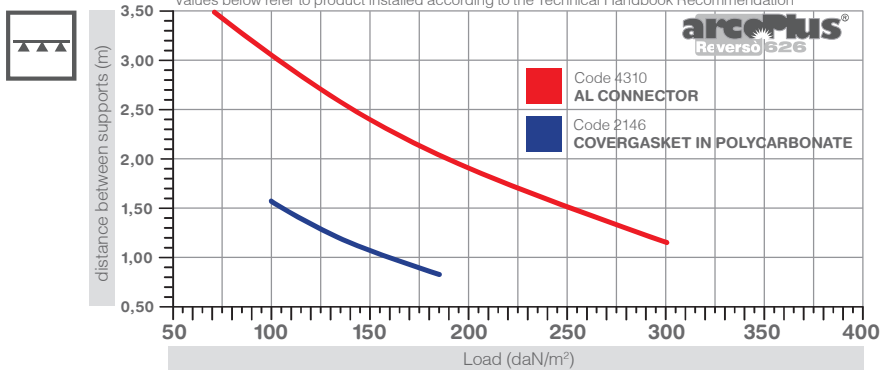

**SYSTEM WITH ALUMINIUM
CONNECTOR CODE 4310**

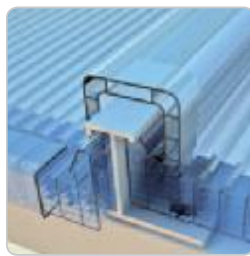

**SYSTEM WITH POLYCARBONATE
COVERGASKET CODE 2146**

EASY AND LOW-COST INSTALLATION

To ensure compliance with snow load and negative wind load resistance requirements, anchor brackets should be fitted for each purlin.

The polycarbonate panels are fastened to the underlying structure using specific brackets, which must be anchored to the purlins using suitable self-drilling/self-tapping screws (on

metal structures) and tap bolts (for wooden structures). These screws and bolts are not supplied.

Different connector profiles can be used, depending on the required load specifications.



COMPLETE ROOFING SYSTEM

Modular multiwall polycarbonate panels for the construction of flat or curved roofing. The panels are anchored to the supporting structure using specific aluminium brackets to guarantee load strength. Depending on the load capacity values required, or the distance between the purlins of the underlying structures, either polycarbonate cover plates can be used or, for greater strength, aluminium connectors.

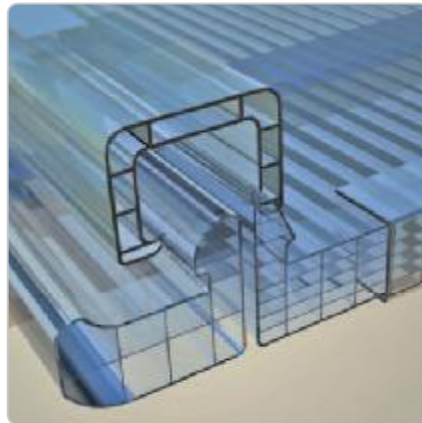
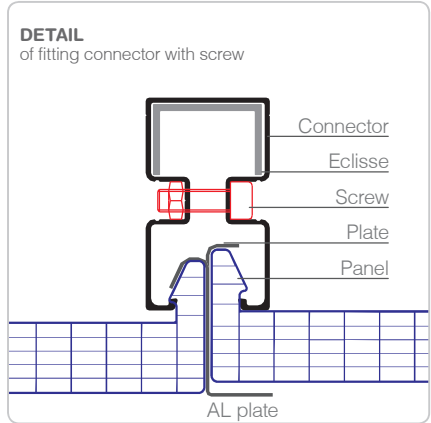

DETAIL OF START PROFILE
Start profile with panel, cover plate, plate and air cell cover profiles.

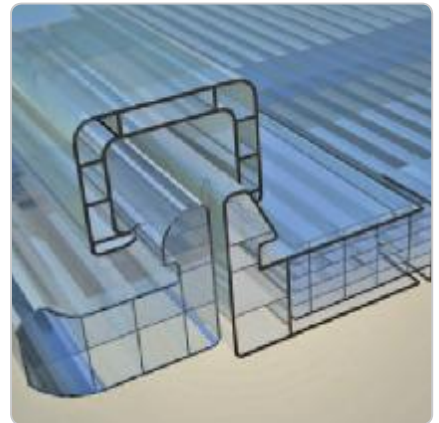

DETAIL OF END PROFILE
Detail of insertion of section-breaker profile to complete roofing.

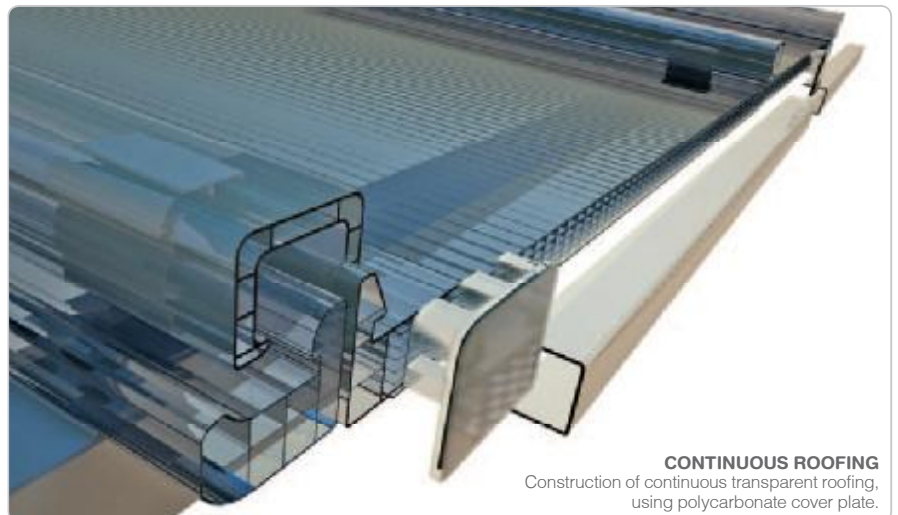

CONTINUOUS ROOFING
Construction of continuous transparent roofing, using polycarbonate cover plate.



ACCESSORIES

The arcoPlus® system includes a complete range of accessories to facilitate installation.

The air cells of the panels must be sealed using a specific polycarbonate profile or vented aluminium breather tape. This allows correct ventilation and prevents soiling on the inside.

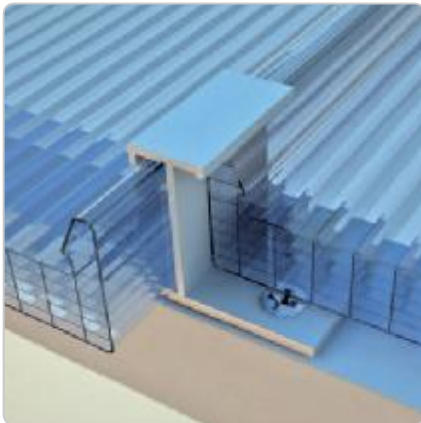

DETAIL OF ANCHORAGE
Profiles anchored to supporting structures using aluminium plates.

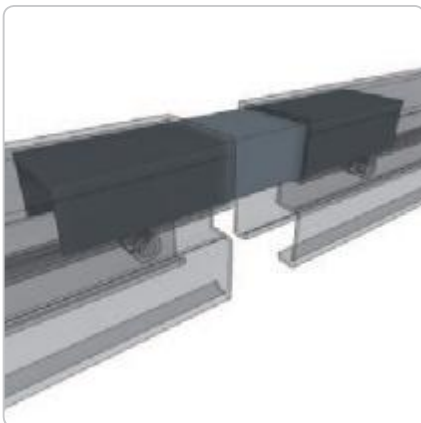

CONNECTOR JOINT
AL connector profiles with eclipse.

METAL PROFILES

code 4310
Connector AL
profile with screw

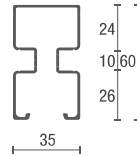

code 4271
Base-side AL profile
with frontal opening

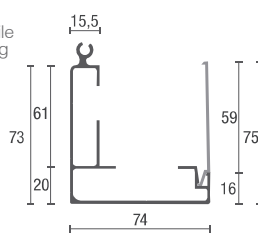

code 4252
closing
support in AL



4329
Guarnizione PE-LD
4x15mm



4316 M6 nut
4315 M6 x 20 screw
Accessories for connector



2182
Block cover



4327
Additional tape



ACCESSORIES



4303
Covergasket
stopper



2146
Covergasket
in polycarbonate



2282
Double connector
in polycarbonate



2179
Start profile
in polycarbonate



2180
End profile
in polycarbonate



4310
Connector AL
profile with screw



4271
Base-side AL profile
with frontal opening



4252
closing
support in AL



4319/200
AL eclipse
for connector



4328
AL plate



4264
Stainless steel plate
for vertical connection



4263
Stainless steel plate
for flat connection



4213 dim. 40x35x580
4221 dim. 70x40x580
Pad PE-LD



4318
Pad PE-LD
for connector

2.3 MODULAR OVERLAPPING SYSTEMS

arcoPlus[®]
1000



PROFILE

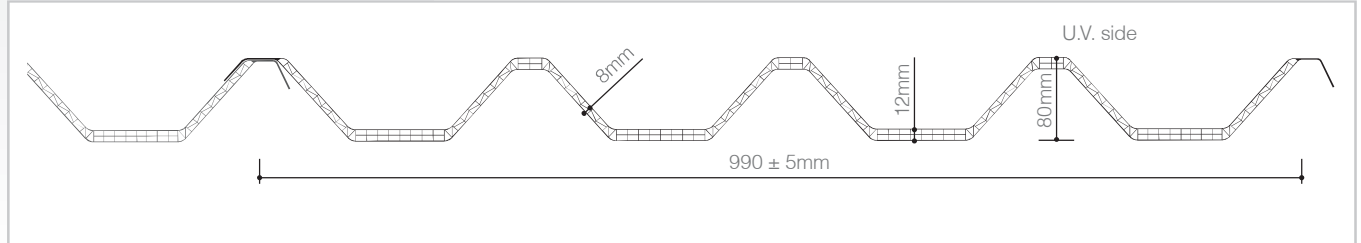

**Modular system
of corrugated UV
protected multiwall
polycarbonate for
translucent curtain
walls and roofing**

PRODUCTION STANDARDS

thickness	variable 8÷12mm
profile height	80mm
structure	3 walls
modular width	990 - 1.000mm
colours available	see page 11

TECHNICAL FEATURES

Thermal insulation	2,7 W/m ² K
Acoustic insulation	16 dB
Linear thermal expansion	0,065mm/m°C
Temperature range	-40°C +120 °C
U.V. rays protection	Coextrusion
Fire reaction EN 13501	EuroClass Bs1d0
Accidental shock resistance	1.200 Joule



DESCRIPTION

arcoPlus1000[®] is a modular corrugated system consisting of 3 coextruded polycarbonate walls, in 8÷12mm thickness, perfectly overlapping lengthwise and enabling continuous coverage and skylights filled gutter. Considering the linear thermal expansion of polycarbonate, to avoid cracks at the through fixings the recommended maximum length is 5,000mm.

ADVANTAGES

- ❖ High load resistance
- ❖ Longitudinal overlap
- ❖ Transverse overlap
- ❖ Thermowelded panels
- ❖ Light transmission
- ❖ Resistance to U.V. rays and to hail
- ❖ Heat insulation

APPLICATIONS

-  Vertical windows
-  Roofing

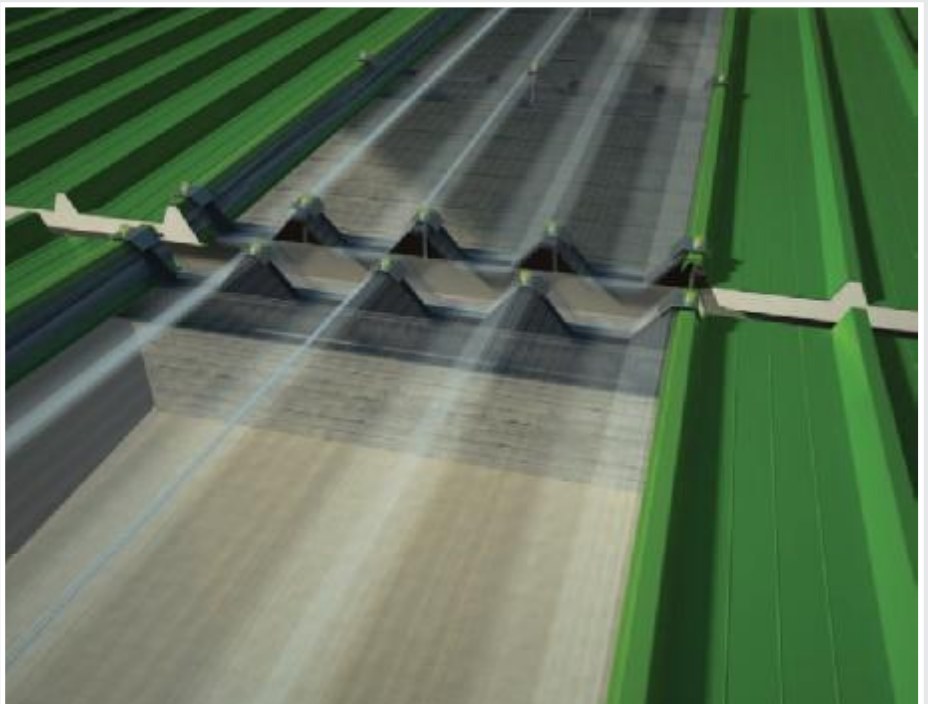

SKYLIGHT - PANEL APPLICATION
Construction of skylight with lateral overlapping of insulating roofing panels. Detail of valley gutter.



LOAD RESISTANCE SKYLIGHT - SINGLE PANEL SYSTEM

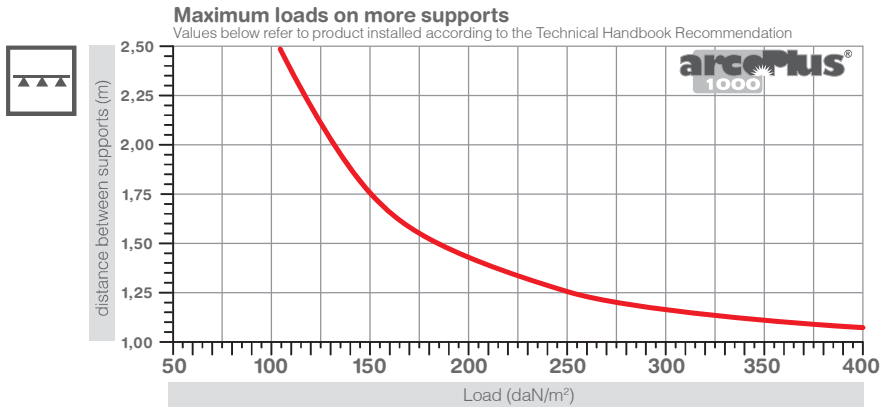

SKYLIGHT GUTTER RIDGE APPLICATION

Panels laterally overlapping insulated corrugated metal roofing panels. Thanks to the specific design of the profile the system is perfectly compatible for overlapping all the main types of panel.

Minimum slope 5%.

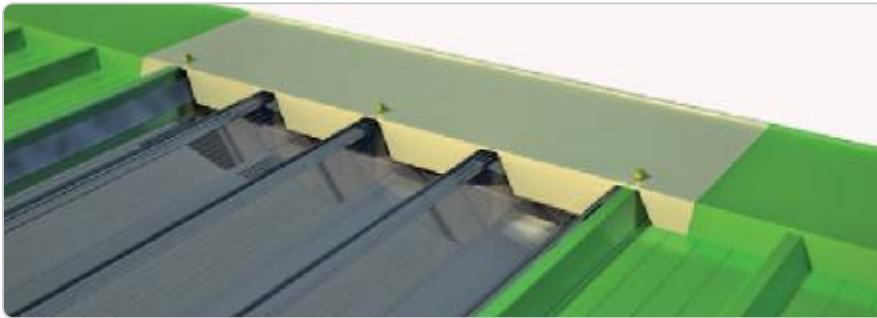

SHEET METAL RIDGE
 Pre-painted galvanized steel sheet ridge profile, consisting of two half-ridges



COVER FOOT
 Detail of lateral overlapping with insulated metal panels. Fastening of cover foot.



LOAD RESISTANCE OF MULTIPLE PANEL CONTINUOUS ROOFING SYSTEM

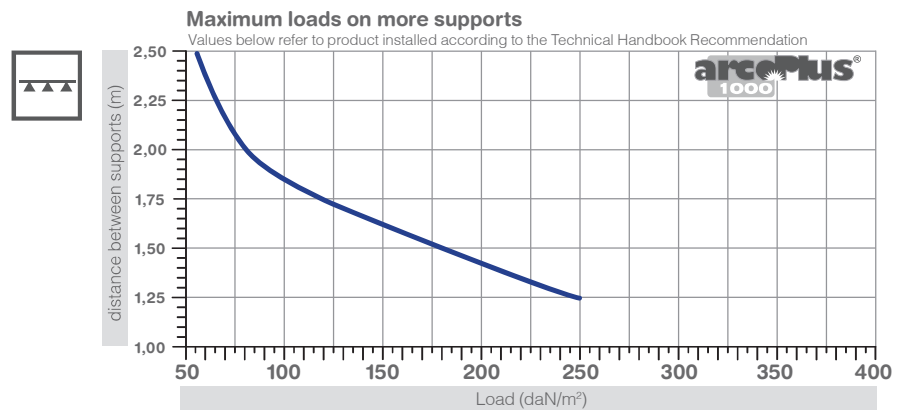

APPLICATION ON CONTINUOUS ROOFING

Construction of continuous roofing/wall with continuous lateral overlapping of polycarbonate panels.

For roofing, recommended minimum slope 7%.



CONTINUOUS ROOFING

Construction of continuous translucent roofing, with overlapping of panels. Recommended minimum slope 7%.



ACCESSORIES

arcoPlus®1000 is a complete system for the construction of translucent curtain walls/roofing. It includes a range of accessories that make it suitable for all purposes. In addition to complete fastening assemblies, the system includes a tongue and groove seal, a flat strip for sealing overlap areas, a range of steel profiles including bracing brackets, and a special press-formed profile to be inserted as a reinforcement on the groove side of the panel. For continuous roofing the panels are arranged with a continuous lateral overlap.

A flat ridge to place over the adjacent ridge profiles completes the range of accessories. Standard panels are supplied with heat-sealed ends to prevent soiling inside the air cells.



ANCHORAGE OF ROOFING
This is done using an aluminium cap with Vipla washer and self-drilling screw.

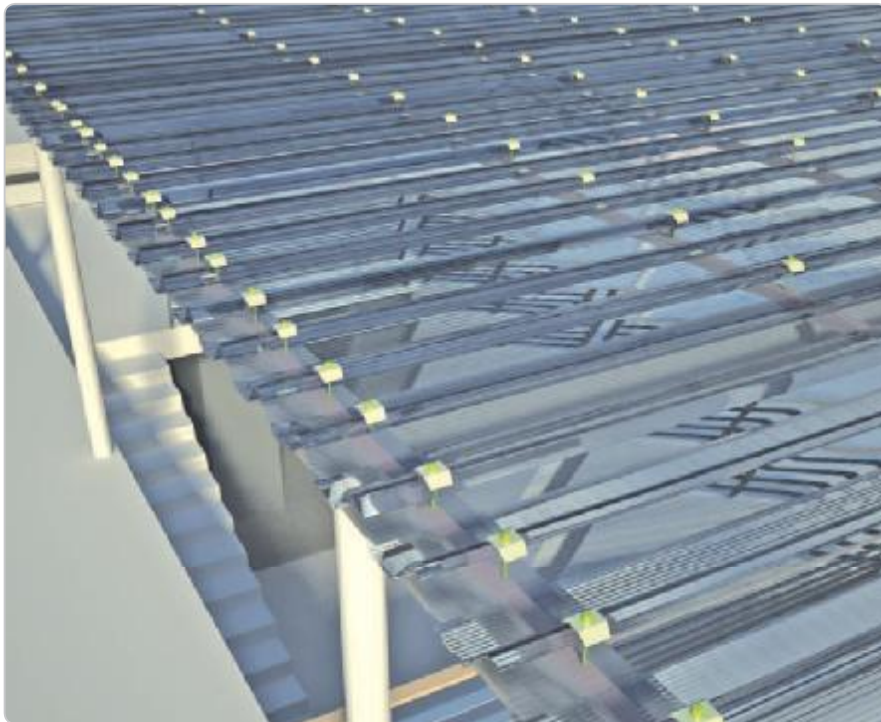

ACCESSORIES



4234
Aluminium cap with gasket



4233
Screw with 6.3x120 Vipla washer



4229
Tongue and groove gasket in PE-LD



4250
Gasket for gutter in PE-LD



4236
Protected steel profile



4235
Central bracing bracket



4232
Sealant tape PE-LD 20x10



4231
Roof profile (2 pieces)

2.3 MODULAR OVERLAPPING SYSTEMS

arcoPlus[®]
1000Curvo

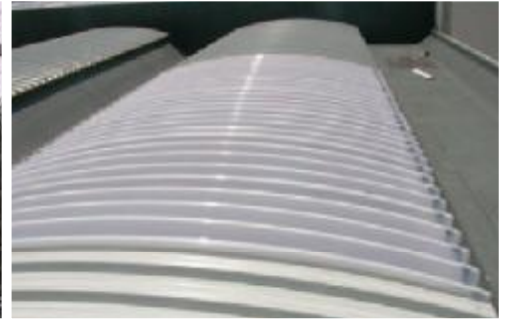

PROFILE

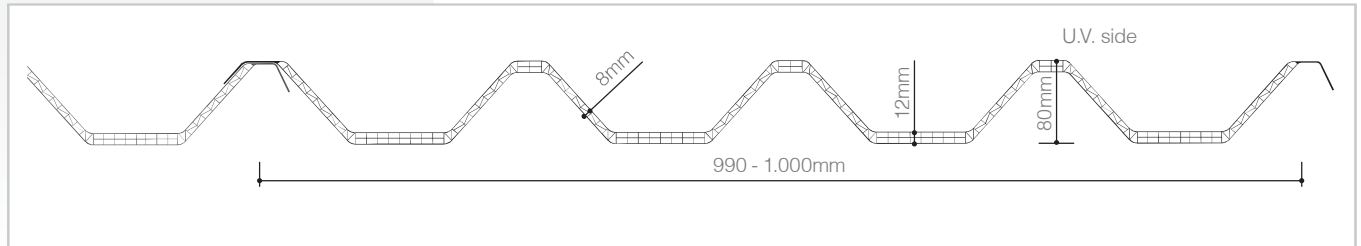

Modular system of corrugated UV protected multiwall polycarbonate for curved translucent roofing

PRODUCTION STANDARDS

thickness	variable 8÷12mm
profile height	80mm
structure	3 walls
modular width	990 - 1.000mm
colours available	see page 11

TECHNICAL FEATURES

Thermal insulation	2,7 W/m ² K
Acoustic insulation	16 dB
Linear thermal expansion	0,065mm/m°C
Temperature range	-40°C +120 °C
U.V. rays protection	Coextrusion
Fire reaction EN 13501	EuroClass B-s1,d0
Accidental shock resistance	1.200 Joule

SKYLIGHT PANEL

Creation of skylights, achieved by means of lateral overlapping of translucent components with curved metal insulated panels.

CONTINUOUS ROOFING

Creation of continuous roofing, achieved by means of continuous lateral overlapping of polycarbonate panels. Components are manufactured with a bend radius of R.3,300mm or R.6,000mm.

ADVANTAGES

- ❖ High load resistance
- ❖ Longitudinal overlap
- ❖ Thermowelded panels
- ❖ Light transmission
- ❖ Resistance to U.V. rays and to hail
- ❖ Thermal insulation

APPLICATIONS



Curved roofing

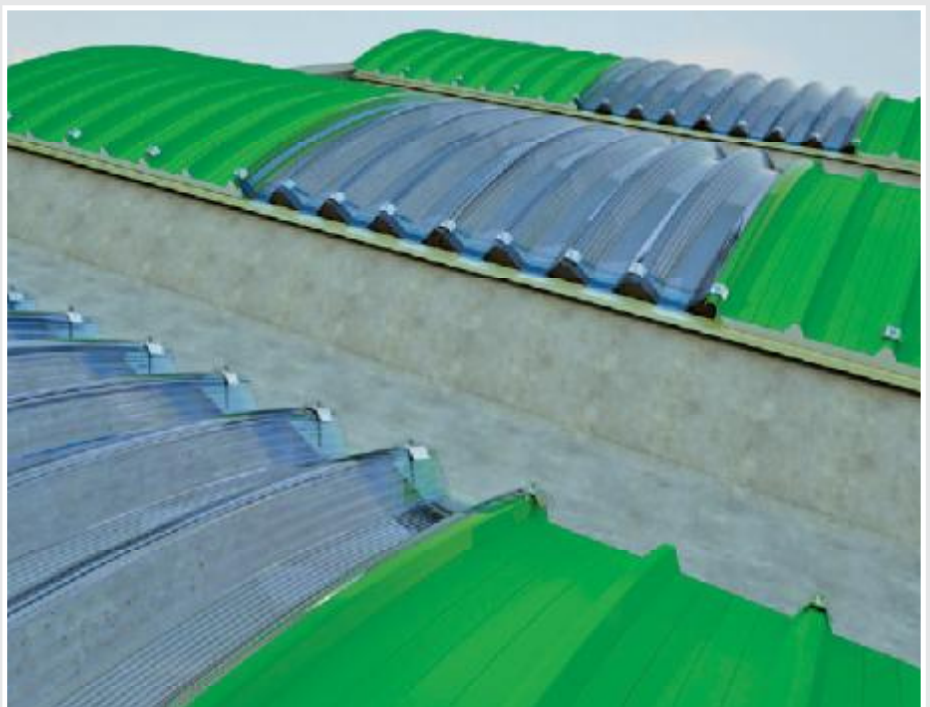

CURVED ROOFING
Detail of curved roofing in use with insulated metal panels.

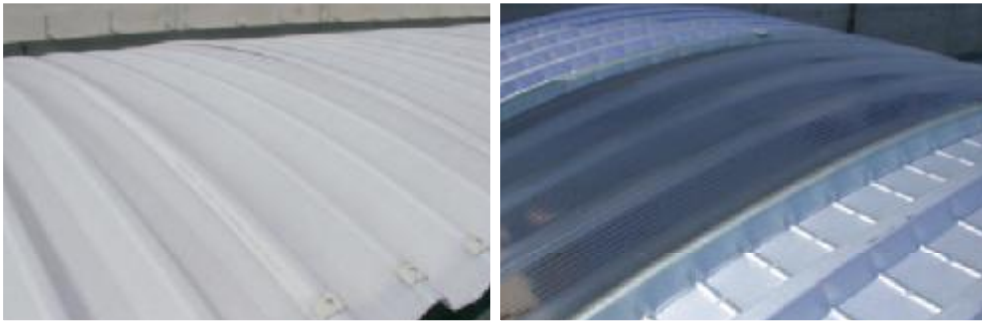

CURVED SYSTEM LOAD RESISTANCE

Maximum loads on two supports - R.3.300 - R.6.000mm

Values below refer to product installed according to the Technical Handbook Recommendation

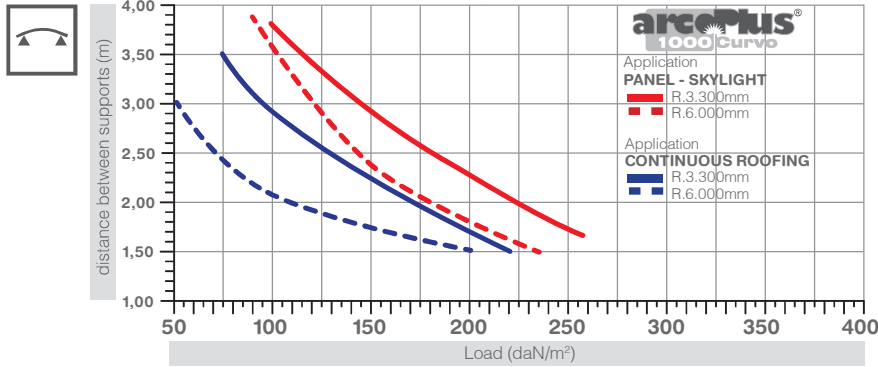

DETAIL OF ANCHORAGE

Detail of anchorage of panels to supporting structures.

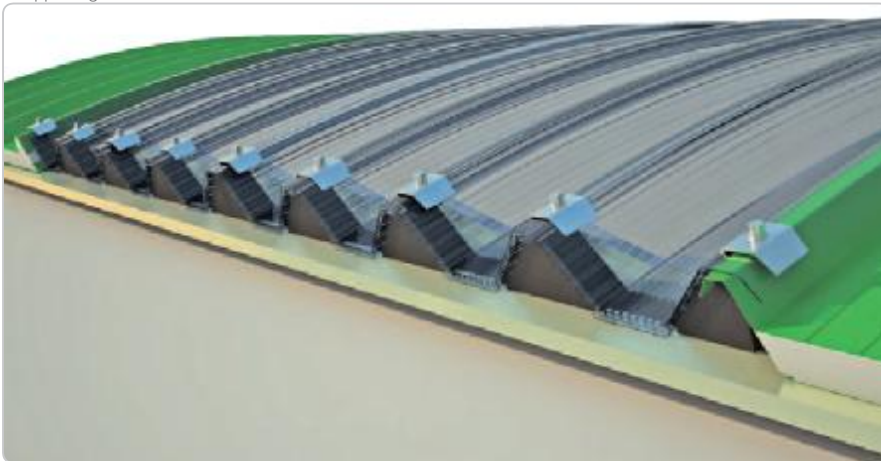



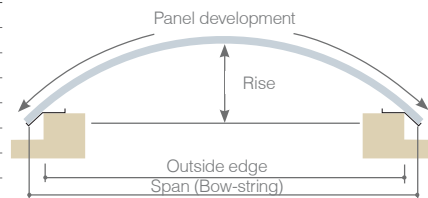

DEVELOPMENT TABLE

Span	R.3.300mm		R.6.000mm	
	Rise	Development	Rise	Development
1.000	38	1.016	21	1.008
1.200	55	1.221	30	1.210
1.400	75	1.428	41	1.413
1.600	98	1.636	54	1.615
1.800	125	1.845	68	1.819
2.000	155	2.057	84	2.023
2.200	189	2.270	102	2.227
2.400	226	2.486	121	2.432
2.600	267	2.705	143	2.638
2.800	312	2.927	166	2.845
3.000	361	3.152	191	3.052
3.200	414	3.381	217	3.261
3.400	472	3.615	246	3.470
3.600	534	3.854	276	3.681
3.800	602	4.098	309	3.892
4.000	675	4.349	343	4.105
4.200	754	4.608	380	4.319
4.400	840	4.875	418	4.535
4.600	935	5.151	458	4.752
4.800	1.035	5.439	501	4.971



ACCESSORIES

- 
4234
Aluminium cap with gasket
- 
4233
Screw with 6.3x120 Vipla washer
- 
4250
Gasket for gutter PE-LD
- 
4235
Central bracing bracket
- 
4232
Sealant tape PE-LD 20x10

ACCESSORIES

arcoPlus®1000 is a complete system for the construction of translucent roofing and includes a range of accessories that make it suitable for all purposes.

Standard panels are supplied with heat-sealed ends to prevent soiling inside the air cells.

2.3 MODULAR OVERLAPPING SYSTEMS

arcoPlus®
SUPER 1000



PROFILE

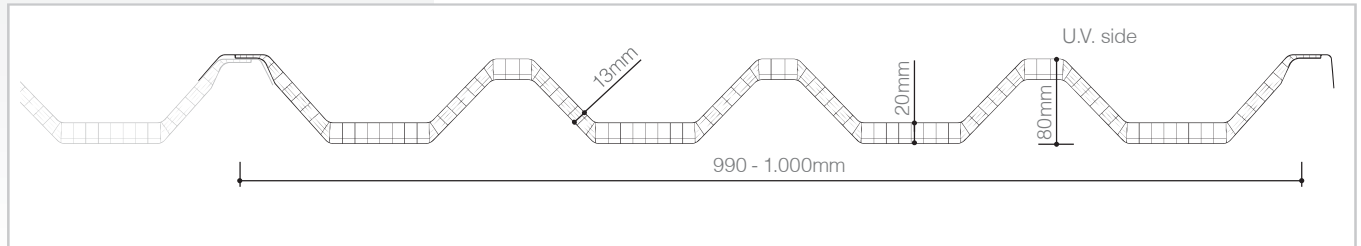

Modular system of corrugated UV protected multiwall polycarbonate for translucent curtain walls and roofing

PRODUCTION STANDARDS

thickness	variable 13÷20mm
profile height	80mm
structure	5 walls
modular width	990 - 1.000mm
colours available	see page 11

TECHNICAL FEATURES

Thermal insulation	1,8 W/m²K
Acoustic insulation	18 dB
Linear thermal expansion	0,065mm/m°C
Temperature range	-40°C +120 °C
U.V. rays protection	Coextrusion
Fire reaction EN 13501	EuroClass B-s1,d0
Accidental shock resistance	1.200 Joule

DESCRIPTION



arcoPlus®SUPER1000 is a modular corrugated system consisting of 5 co-extruded polycarbonate walls, in 13÷20mm thickness, perfectly overlapping lengthwise and enabling continuous coverage and skylights filled gutter. Considering the linear thermal expansion of polycarbonate, to avoid cracks at the through fixings the recommended maximum length is 5,000mm.

For higher length of the pitch is better the use of multiple overlapping panels.

ADVANTAGES

- ❖ High load resistance
- ❖ Longitudinal overlap
- ❖ Transverse overlap
- ❖ Thermowelded panels
- ❖ Light transmission
- ❖ Resistance to U.V. rays and to hail
- ❖ Heat insulation

APPLICATIONS

-  Vertical windows
-  Roofing

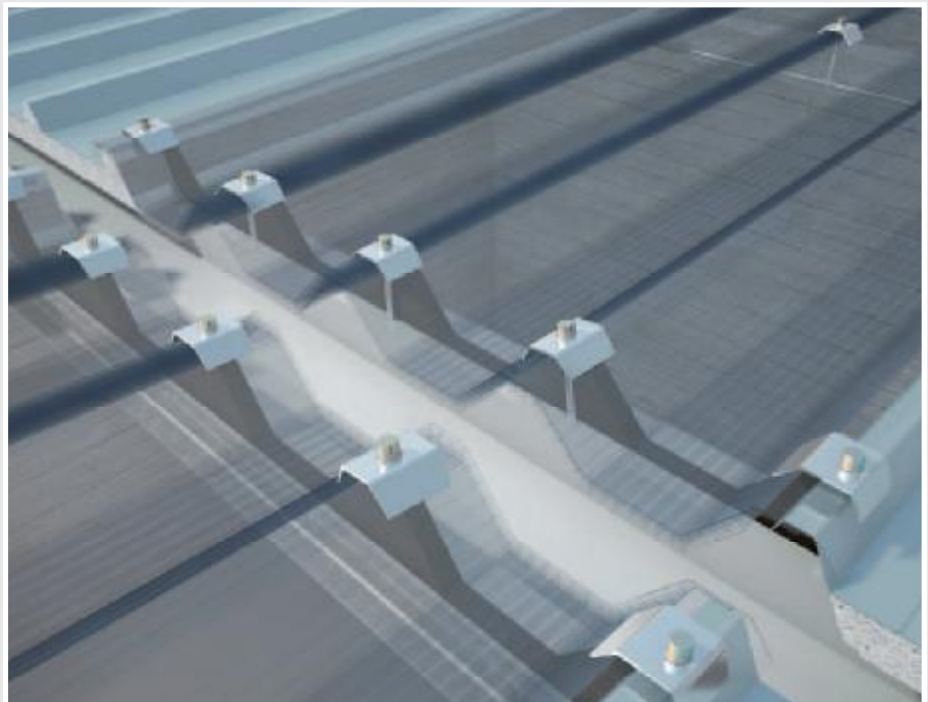

SKYLIGHT - PANEL APPLICATION

Construction of skylight with lateral overlapping of insulating roofing panels. Detail of valley gutter.



LOAD RESISTANCE SKYLIGHT - SINGLE PANEL SYSTEM

Maximum loads on more supports

Values below refer to product installed according to the Technical Handbook Recommendation

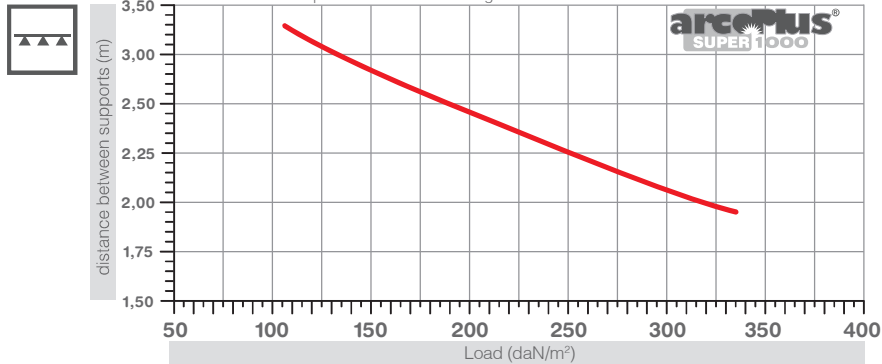

SKYLIGHT GUTTER RIDGE APPLICATION

Panels laterally overlapping insulated corrugated metal roofing panels. Thanks to the specific design of the

profile the system is perfectly compatible for overlapping all the main types of panel. Minimum slope 5%.

LOAD RESISTANCE OF MULTIPLE PANEL CONTINUOUS ROOFING SYSTEM

Maximum loads on more supports

Values below refer to product installed according to the Technical Handbook Recommendation

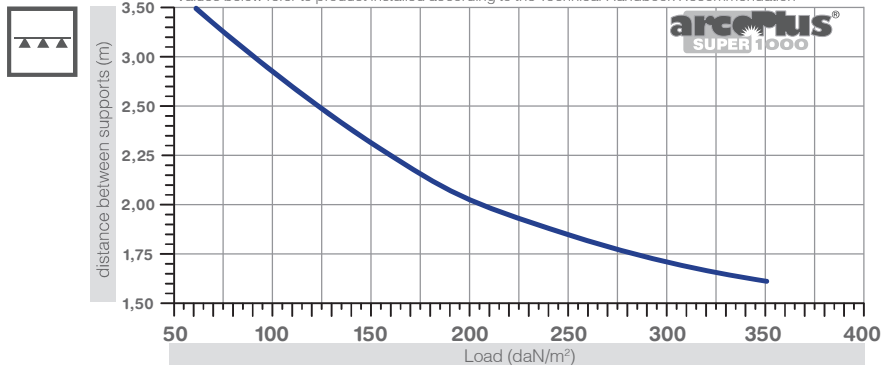

APPLICATION ON CONTINUOUS ROOFING

Construction of continuous roofing/wall with continuous lateral overlapping of polycarbonate panels. For roofing, recommended minimum slope 7%.

a tongue and groove seal, a flat strip for sealing overlap areas, a range of steel profiles including bracing brackets, and a special press-formed profile to be inserted as a reinforcement on the groove side of the panel. For continuous roofing the panels are arranged with a continuous lateral overlap.

A flat ridge to place over the adjacent ridge profiles completes the range of accessories. Standard panels are supplied with heat-sealed ends to prevent soiling inside the air cells.

ACCESSORIES

arcoPlus®SUPER1000 is a complete system for the construction of translucent curtain walls/roofing. It includes a range of accessories that make it suitable for all purposes. In addition to complete fastening assemblies, the system includes

ACCESSORIES



4234
Aluminium cap with gasket



4233
Screw with 6.3x120 Vipla washer



4655
Tongue and groove gasket in PE-LD



4658
Gasket for gutter in PE-LD



4236
Protected steel profile



4235
Central bracing bracket



4232
Sealant tape PE-LD 20x10



4231
Roof profile (2 pieces)

2.3 MODULAR OVERLAPPING SYSTEMS

arcoPlus®
SUPER 1000 Curvo



PROFILE

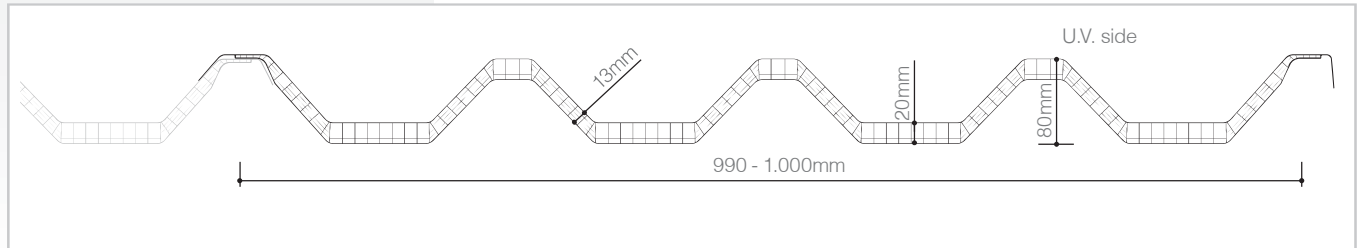

Modular system of corrugated UV protected multiwall polycarbonate for curved translucent roofing

PRODUCTION STANDARDS

thickness	variable 13÷20mm
profile height	80mm
structure	5 walls
modular width	990 - 1.000mm
colours available	see page 11

TECHNICAL FEATURES

Thermal insulation	1,8 W/m²K
Acoustic insulation	18 dB
Linear thermal expansion	0,065mm/m°C
Temperature range	-40°C +120 °C
U.V. rays protection	Coextrusion
Fire reaction EN 13501	EuroClass B-s1,d0
Accidental shock resistance	1.200 Joule

SKYLIGHT PANEL

Creation of skylights, achieved by means of lateral overlapping of translucent components with curved metal insulated panels.

CONTINUOUS ROOFING

Creation of continuous roofing, achieved by means of continuous lateral overlapping of polycarbonate panels. arcoPlus®SUPER1000 is produced with a radius of curvature R.3.000mm and R. 6.000mm.

ADVANTAGES

- ❖ High load resistance
- ❖ Longitudinal overlap
- ❖ Thermowelded panels
- ❖ Light transmission
- ❖ Resistance to U.V. rays and to hail
- ❖ Thermal insulation

APPLICATIONS



Curved roofing

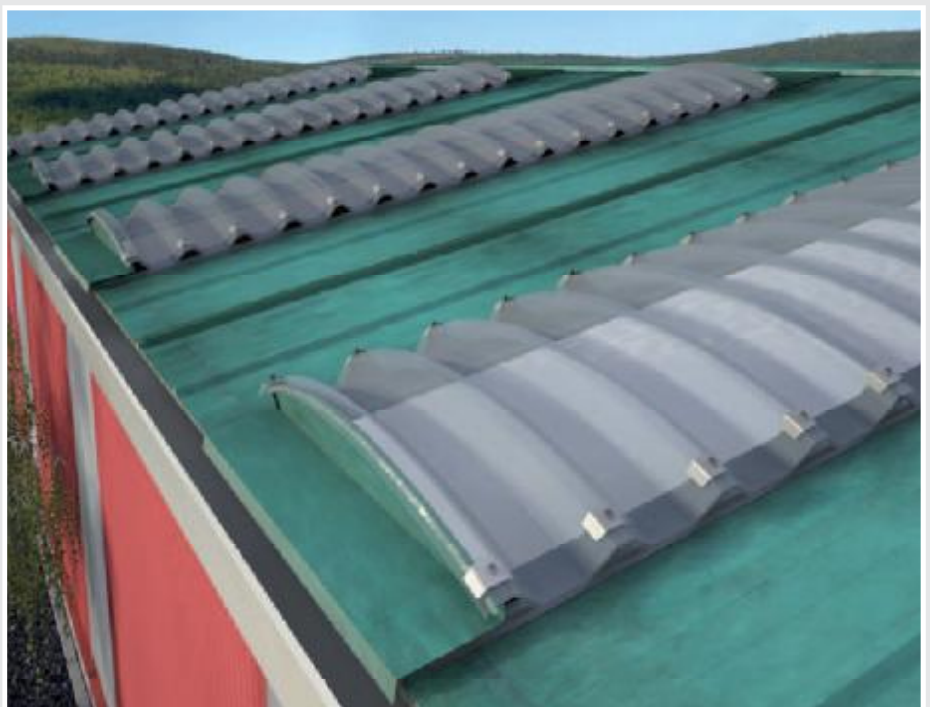

SKYLIGHT PANELS APPLICATION

Skylight gutter ridge application with cross disposition of the bent panels in polycarbonate



RESISTENZA AL CARICO SISTEMA CURVO

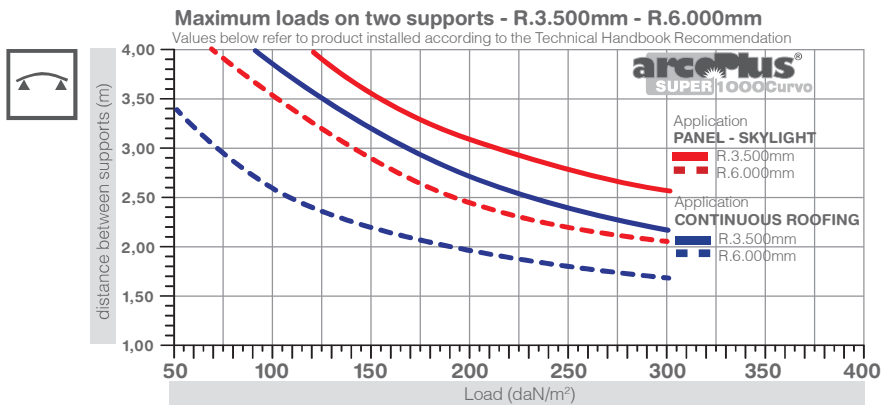

DETAIL OF ANCHORAGE

detail of fixing panels to support structures

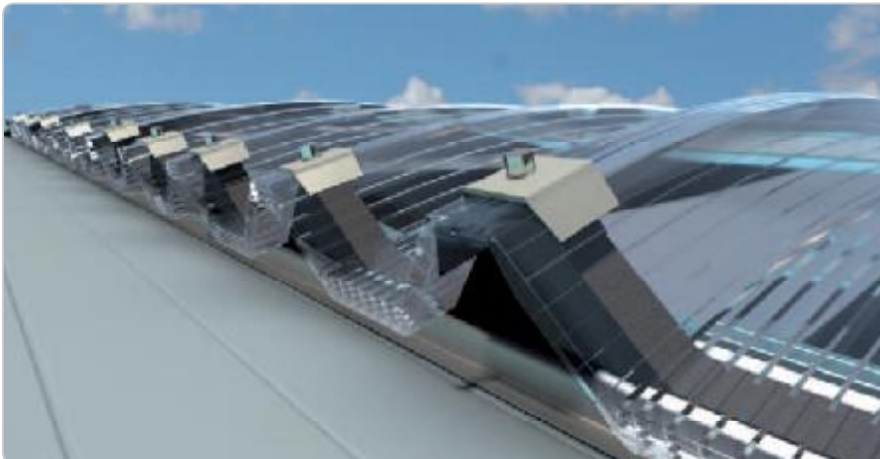

DEVELOPMENT TABLE

Span	R.3.500mm		R.6.000mm	
	Rise	Development	Rise	Development
1.000	36	1.015	21	1.008
1.200	52	1.220	30	1.210
1.400	71	1.426	41	1.413
1.600	93	1.633	54	1.615
1.800	118	1.841	68	1.819
2.000	146	2.051	84	2.023
2.200	177	2.264	102	2.227
2.400	212	2.478	121	2.432
2.600	250	2.694	143	2.638
2.800	292	2.914	166	2.845
3.000	338	3.136	191	3.052
3.200	387	3.361	217	3.261
3.400	441	3.591	246	3.470
3.600	498	3.824	276	3.681
3.800	561	4.063	309	3.892
4.000	628	4.306	343	4.105
4.200	700	4.556	380	4.319
4.400	778	4.812	418	4.535
4.600	862	5.077	458	4.752
4.800	952	5.350	501	4.971

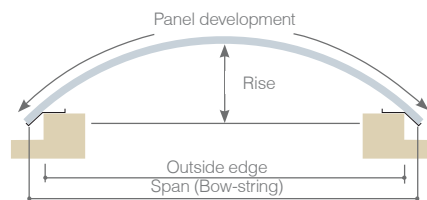

ACCESSORIES

arcoPlus®SUPER1000 is a complete system for the construction of translucent roofing and includes a range of accessories that make it suitable for all purposes. Standard panels are supplied with heat-sealed ends to prevent soiling inside the air cells.

ACCESSORIES



4234
Aluminium cap
with gasket



4233
Screw with 6.3x120
Vipla washer



4658
Gasket for gutter
PE-LD



4235
Central bracing
bracket



4232
Sealant tape
PE-LD 20x10

2.3 MODULAR OVERLAPPING SYSTEMS

arcoPlus®
GrecaClick



PROFILE

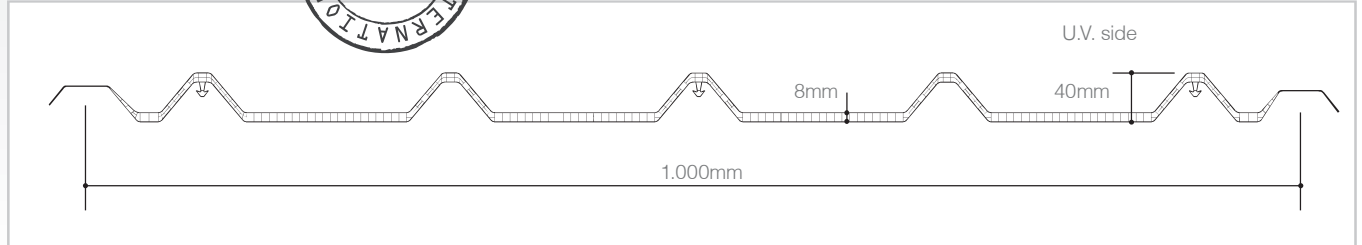

**Modular system
of corrugated UV
protected multiwall
polycarbonate,
assembled using
a snap-on system
without drilling for
translucent curtain
walls and roofing**

PRODUCTION STANDARDS

thickness	8mm
profile height	40mm
structure	3 walls
modular width	1.000mm
colours available	see page 11

TECHNICAL FEATURES

Thermal insulation	3,0 W/m ² K
Acoustic insulation	16 dB
Linear thermal expansion	0,065mm/m°C
Temperature range	-40°C +120 °C
U.V. rays protection	Coextrusion
Fire reaction EN 13501	EuroClass B-s1,d0

DESCRIPTION



Innovative patented roofing system, anchored by pressing it onto specific anchor brackets that allow the polycarbonate sheets to expand without undermining load strength.

N.B. arcoPlus®GrecaCLICK
Supplied with thermowelded ends

ADVANTAGES

- ❖ Pressed on without drilling holes in panels
- ❖ Anchor brackets hidden in the structure
- ❖ Transverse and longitudinal overlap
- ❖ Resistance to U.V. rays and to hail
- ❖ Light transmission
- ❖ Thermowelded sheets
- ❖ Heat insulation

APPLICATIONS

-  Roofing and skylights
-  Vertical windows

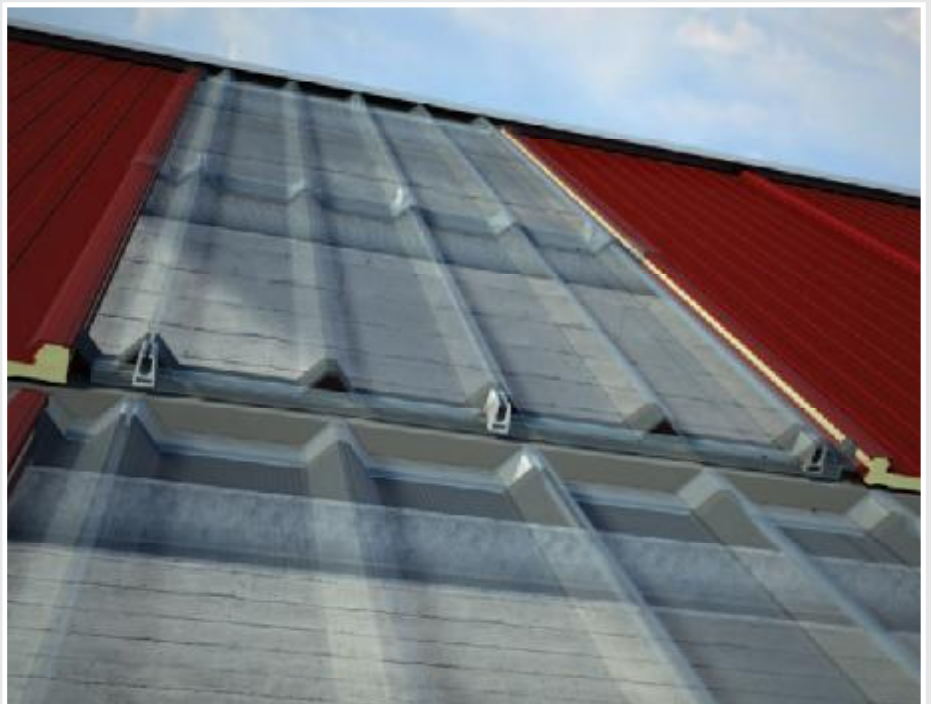

SKYLIGHT - PANEL APPLICATION
Skylight gutter ridge application



SKYLIGHT GUTTER RIDGE APPLICATION

Skylight obtained by laterally overlapping with all types of foamed roofing panels or corrugated sheets. The special method of connection guarantees resistance to dynamic wind loads while at the same time allowing the material to expand. Recommended minimum slope 5%.

CONTINUOUS ROOFING APPLICATION

Construction of continuous roofing with continuous lateral overlapping of components. Recommended minimum slope 7%.

LOAD RESISTANCE

Maximum loads on more supports

Values below refer to product installed according to the Technical Handbook Recommendation

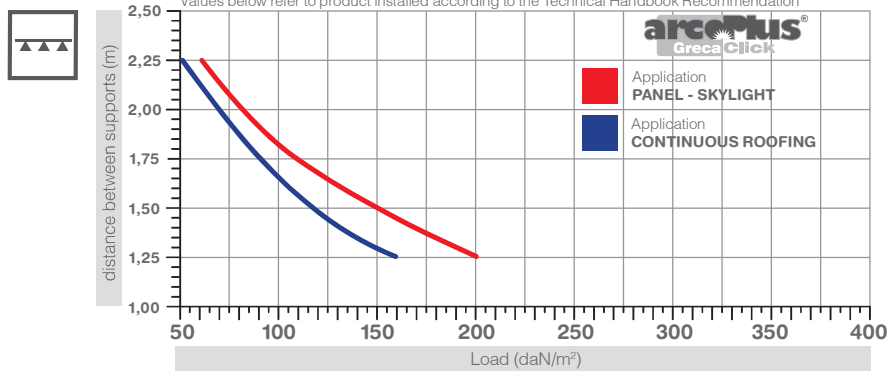

DETAIL OF RIDGE
Detail of ridge with PE-LD seal

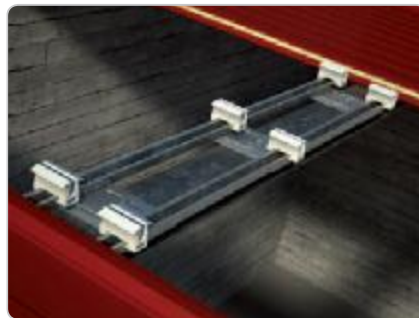

OVERLAP - STEP 1
Detail of double anchor bracket anchored to roofing structure



OVERLAP - STEP 2
Insertion of lower sheet by pressing

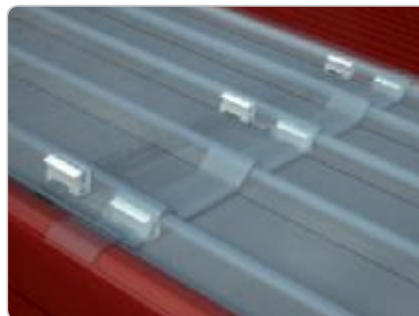

OVERLAP - STEP 3
Insertion of upper sheet by pressing

ACCESSORIES



4420 Kit 20
4423 Kit 30
4424 Kit 40
GrecaClick connection kit



4425 Kit 20
4427 Kit 30
4429 Kit 40
GrecaClick overlap kit



4406 Kit 0
4407 Kit 20
4408 Kit 30
4409 Kit 40
PE-LD GrecaClick ridge bird comb kit

N.B. arcoPlus®GrecaCLICK
Supplied with thermowelded ends

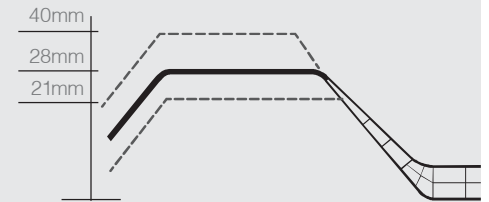

The ends of the sheets can be modified for use with different roofing profiles.

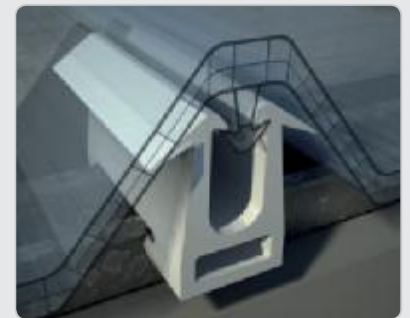

ANCHORAGE OF ROOFING
This is done by pressing onto the anchor bracket.



DETAIL OF GUTTER
Detail of insertion of the PE-LD seal.

2.3
MODULAR
OVERLAPPING SYSTEMS

arcoPlus®
MiniGreca



PROFILE

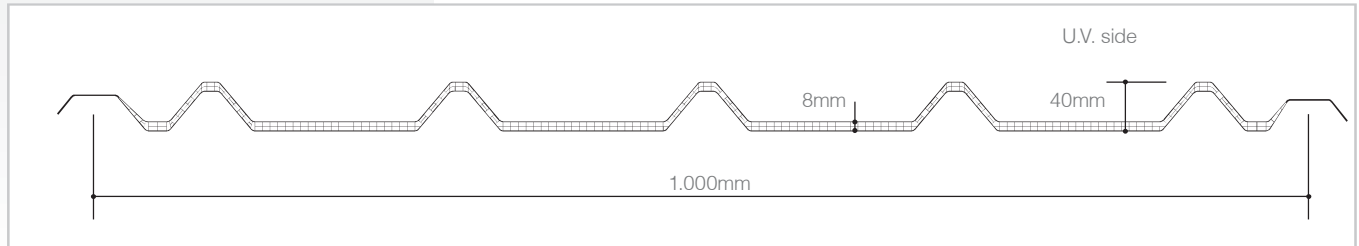

**Modular system
of corrugated UV
protected multiwall
polycarbonate for
translucent curtain
walls and roofing
applications**

PRODUCTION STANDARDS

thickness	8mm
profile height	40mm
structure	3 walls
modular width	1.000mm
colours available	see page 11

TECHNICAL FEATURES

Thermal insulation	3,0 W/m ² K
Acoustic insulation	16 dB
Linear thermal expansion	0,065mm/m°C
Temperature range	-40°C +120 °C
U.V. rays protection	Coextrusion
Fire reaction EN 13501	EuroClass B-s1,d0

DESCRIPTION

arcoPlus®MiniGreca, is a complete system for the construction of translucent curtain walls and roofing and includes a range of accessories that make it suitable for all purposes. Thanks to the specific design of the profile the system is perfectly compatible with all the main types of panel.

N.B. arcoPlus®MiniGreca
Supplied with thermowelded ends

ADVANTAGES

- ❖ Transverse and longitudinal overlap
- ❖ Resistance to U.V. rays and to hail
- ❖ Light transmission
- ❖ Thermowelded sheets
- ❖ Heat insulation

APPLICATIONS

-  Roofing and skylights



SKYLIGHT - PANEL APPLICATION
Skylight gutter ridge application



SKYLIGHT GUTTER RIDGE APPLICATION

Skylight obtained by means of lateral overlapping with any type of corrugated roofing sheet.

Recommended minimum slope 5%.



CONTINUOUS ROOFING APPLICATION

Construction of continuous roofing with continuous lateral overlapping of panels. Recommended minimum slope 7%.



ACCESSORIES



4433
Aluminium cap with gasket



4233
Screw with 6.3x60 Vipla washer



4406 Kit 0 - 40
4404 Kit 21 - 28
PE-LD GrecaClick ridge bird comb kit



4405
Gasket for gutter PE-LD

LOAD RESISTANCE

Maximum loads on more supports

Values below refer to product installed according to the Technical Handbook Recommendation

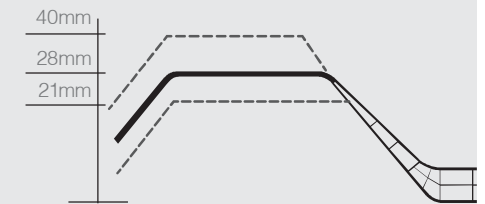
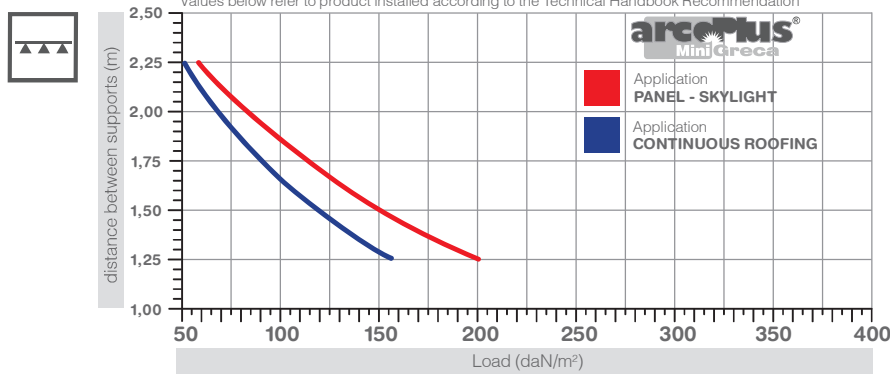

The ends of the sheets can be modified to fit the different types of roofing profile.

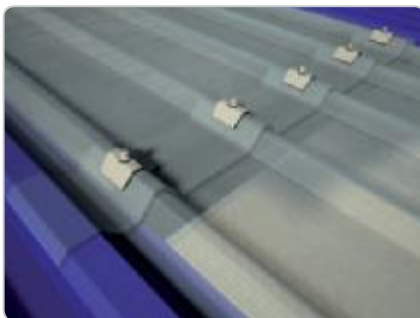

DETAIL OF OVERLAP
Detail of double anchor bracket anchored to roofing structure



DETAIL OF GUTTER
Detail of insertion of the PE-LD seal.



CONTINUOUS ROOFING
Creation of large areas of transparent roofing.



CONTINUOUS ROOFING
Anchorage of roof components



ANCHORAGE OF ROOFING
This is done by drilling and inserting a screw with Vipla washer and cap.

2.3 MODULAR OVERLAPPING SYSTEMS

arcoPlus®
MiniGrecaCurvo



PROFILE

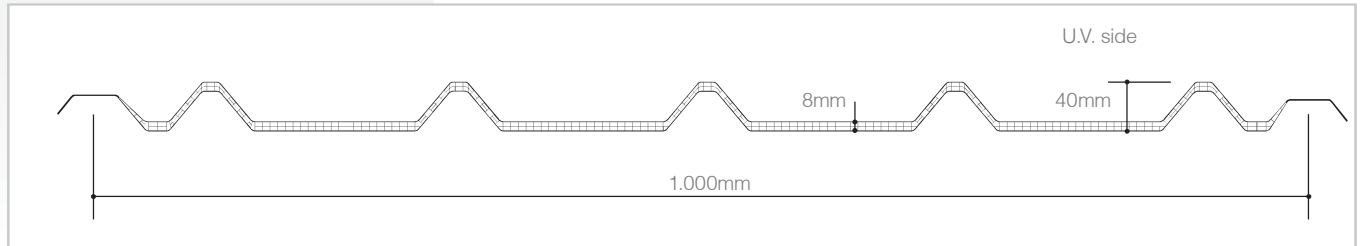

**Modular system
of corrugated UV
protected multiwall
polycarbonate for
curved translucent
roofing**

PRODUCTION STANDARDS

thickness	8mm
profile height	40mm
structure	3 walls
modular width	1.000mm
colours available	see page 11

TECHNICAL FEATURES

Thermal insulation	3,0 W/m ² K
Acoustic insulation	16 dB
Linear thermal expansion	0,065mm/m°C
Temperature range	-40°C +120 °C
U.V. rays protection	Coextrusion
Fire reaction EN 13501	EuroClass B-s1,d0

EASY AND LOW-COST INSTALLATION

Creation of continuous roofing, or skylight, achieved by means of continuous lateral overlapping of polycarbonate panels with curved metal insulated panels.

N.B. arcoPlus®MiniGreca
Supplied with thermowelded ends.

ADVANTAGES

- ❖ Transverse and longitudinal overlap
- ❖ Resistance to U.V. rays and to hail
- ❖ Light transmission
- ❖ Thermowelded sheets
- ❖ Heat insulation

APPLICATIONS

 Roofing and skylights



CONTINUOUS ROOFING APPLICATION
Industrial continuous roofing

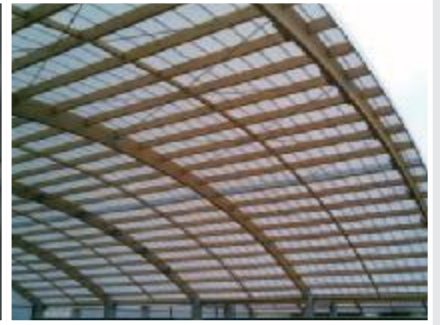

CURVED SYSTEM LOAD RESISTANCE

Maximum loads on two supports - R.3.500mm

Values below refer to product installed according to the Technical Handbook Recommendation

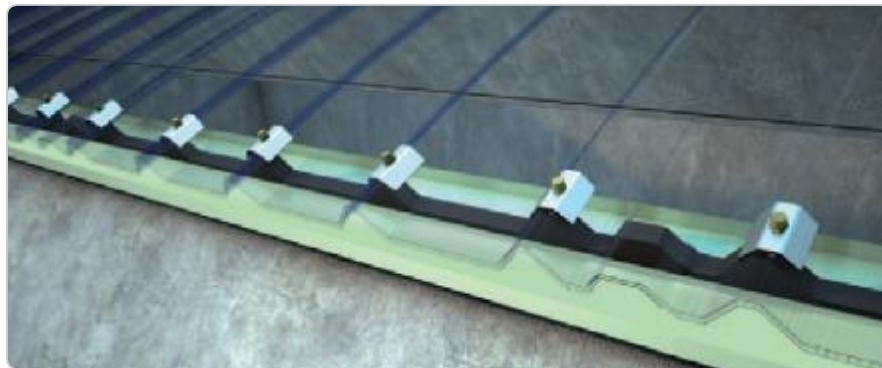
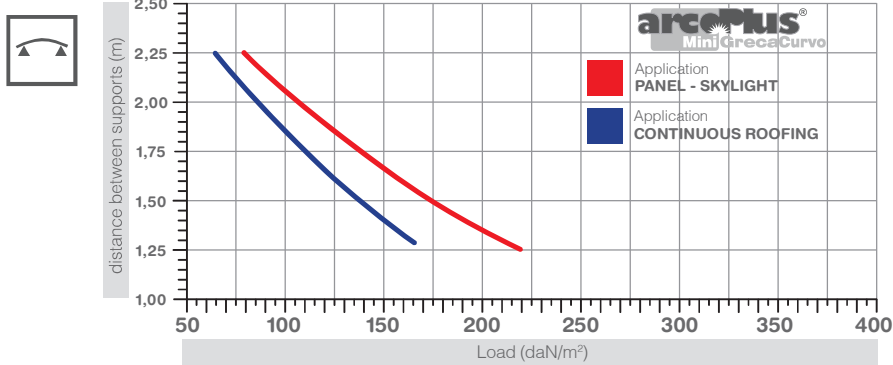

DETAIL OF OVERLAP
Detail of double anchor bracket anchored to roofing structure

DEVELOPMENT TABLE

R.3.500mm

Span	Rise	Development
1.000	36	1.009
1.200	52	1.213
1.400	71	1.418
1.600	93	1.623
1.800	118	1.831
2.000	146	2.040
2.200	177	2.251
2.400	212	2.466
2.600	250	2.679
2.800	292	2.897
3.000	338	3.118

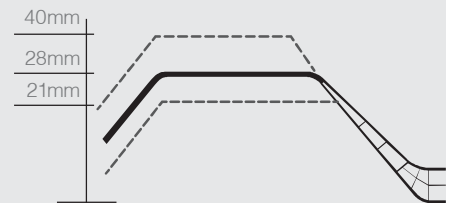
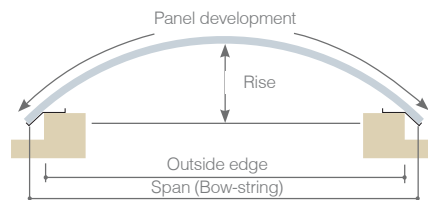

The ends of the sheets can be modified to fit the different types of roofing profile.

ACCESSORIES



4433
Aluminium cap with gasket



4233
Screw with 6.3x60 Vipla washer



4405
Gasket for gutter PE-LD

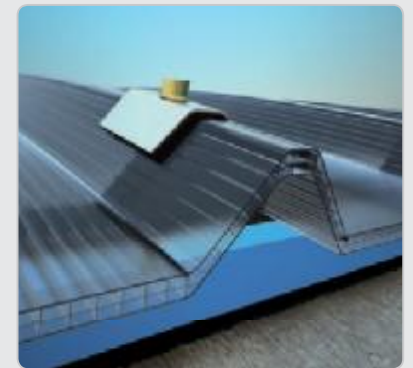

ANCHORAGE OF ROOFING
This is done by drilling and inserting a screw with Vipla washer and cap.

ACCESSORIES

arcoPlus®MiniGreca is a complete system for the construction of translucent roofing and includes a range of accessories that make it suitable for all purposes.

Standard panels are supplied with heat-sealed ends to prevent soiling inside the air cells.

2.3 MODULAR OVERLAPPING SYSTEMS

arcoPlus[®]
Onda



PROFILE

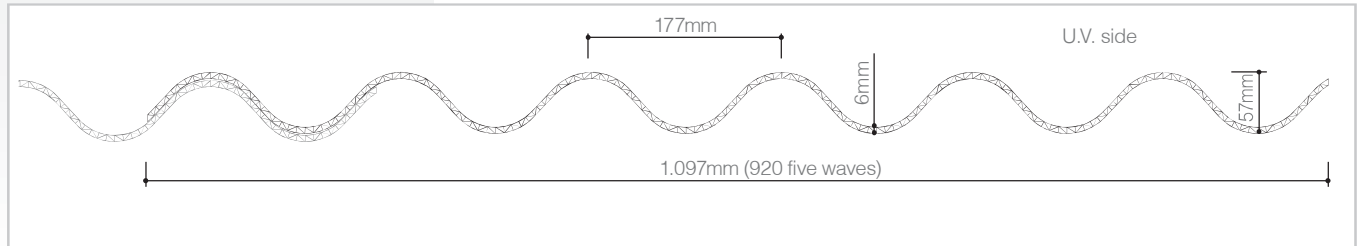

**Modular system
of corrugated UV
protected multiwall
polycarbonate for
vertical walls and
roofings translucent
and opaque**

PRODUCTION STANDARDS

thickness	6mm
profile height	51mm
corrugation pitch	177mm
structure	3 walls with "N" structure
modular width	1.050mm (875 on request)
length	5.000mm (max advised length)
colours available	see page 11

TECHNICAL FEATURES

Thermal insulation	3,2 W/m ² K
Acoustic insulation	16 dB
Linear thermal expansion	0,065mm/m°C
Temperature range	-40°C +120 °C
U.V. rays protection	Coextrusion
Fire reaction EN 13501	EuroClass B-s1,d0
Accidental shock resistance	1.200 Joule





OVERLAP
detail of overlapping components

ADVANTAGES

- ❖ High load resistance
- ❖ Longitudinal and lateral overlap
- ❖ Thermowelded panels
- ❖ Light transmission
- ❖ Resistance to U.V. rays and to hail
- ❖ Heat insulation
- ❖ Easy to install

APPLICATIONS

-  Vertical windows
-  Roofing





SKYLIGHT GUTTER RIDGE APPLICATION

Panels laterally overlap insulated corrugated roofing panels, or fibre cement sheets. Recommended minimum slope 7%.



ROOFING-CONTINUOUS WALL APPLICATION

Construction of continuous roofing/wall with continuous lateral overlapping of polycarbonate panels.



ACCESSORIES



4256
Gasket for gutter
PE-LD



4262 6,3 X 20
4261 6,3 X 90
4374 6,3 X 120
Fixing screw with Buzzer



4232
Sealant tape
PE-LD 20x10

FLAT SYSTEM LOAD RESISTANCE

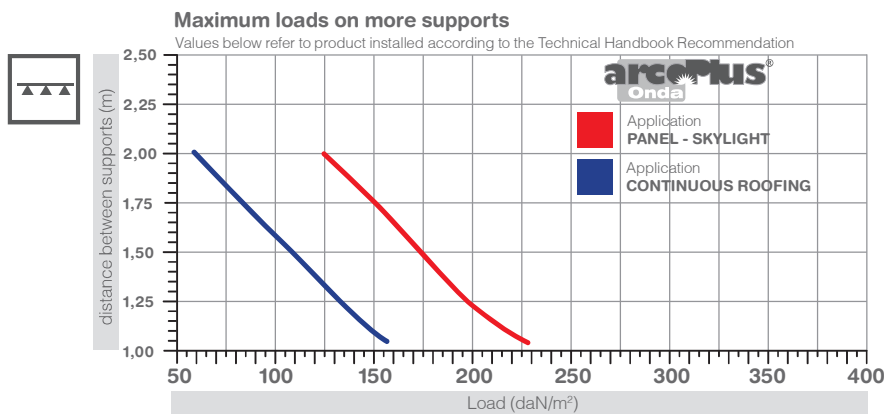

EASY AND LOW-COST INSTALLATION

The arcoPlus®Onda Piano system can be used to construct continuous translucent roofing or combined with fibre cement sheets. The panels must be installed with the UV protected side facing the exterior, to preserve the optical and mechanical properties of the material. If one or more transverse overlaps are required, installation must start from the cover foot (bottom) and then proceed

upwards towards the ridge following the slope of the roof. In particularly windy areas, two-flute overlaps are advisable.

Overlapping can be used to create gutter ridge skylights and continuous skylights with lateral panel overlap.

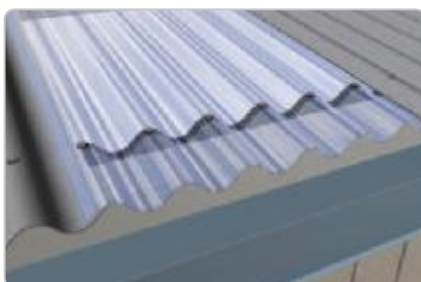

COVER FOOT
detail of gutter line with gasket.



PARTICOLARE SOVRAPPOSIZIONE
detail of overlapping components.

ACCESSORIES

arcoPlus®Onda, system has a complete set of accessories enabling simple installation.

The structure has fixing elements, and gaskets in order to increase resistance in overlapped areas.

arcoPlus®Onda is delivered, as a standard product, with thermowelded extremities.

THERMOWELDING

arcoPlus®Onda is delivered, as a standard product, with thermowelded extremities, up to a max length of 5.000mm.

2.3 MODULAR OVERLAPPING SYSTEMS

arcoPlus®
OndaCurvo



PROFILE

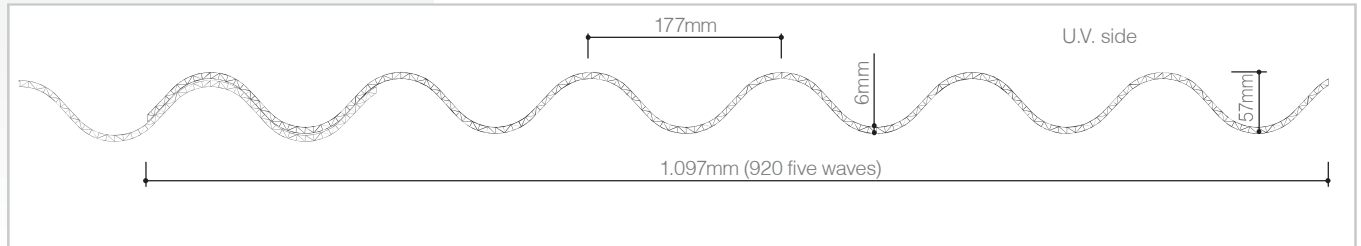

**Modular system
of corrugated UV
protected multiwall
polycarbonate for
curved translucent
and opaque roofing**

PRODUCTION STANDARDS

thickness	6mm
profile height	51mm
corrugation pitch	177mm
structure	3 walls with "N" structure
modular width	1.050mm (875 on request)
length	5.000mm (max advised length)
colours available	see page 11

TECHNICAL FEATURES

Thermal insulation	3,2 W/m ² K
Acoustic insulation	16 dB
Linear thermal expansion	0,065mm/m°C
Temperature range	-40°C +120 °C
U.V. rays protection	Coextrusion
Fire reaction EN 13501	EuroClass B-s1,d0
Accidental shock resistance	1.200 Joule

CURVED SYSTEM APPLICATION

The arcoPlus®Onda Curvo system can be used to create continuous translucent roofing or used, by means of lateral overlapping, with curved fibre cement sheets or insulating panels with a curve radius of R.3,500mm.

The arcoPlus®Onda profile must be installed with the UV protected side facing the exterior, to preserve the optical and mechanical properties of the material.

ADVANTAGES

- ❖ High load resistance
- ❖ Longitudinal and lateral overlap
- ❖ Thermowelded panels
- ❖ Light transmission
- ❖ Resistance to U.V. rays and to hail
- ❖ Heat insulation

APPLICATIONS



Curved roofing

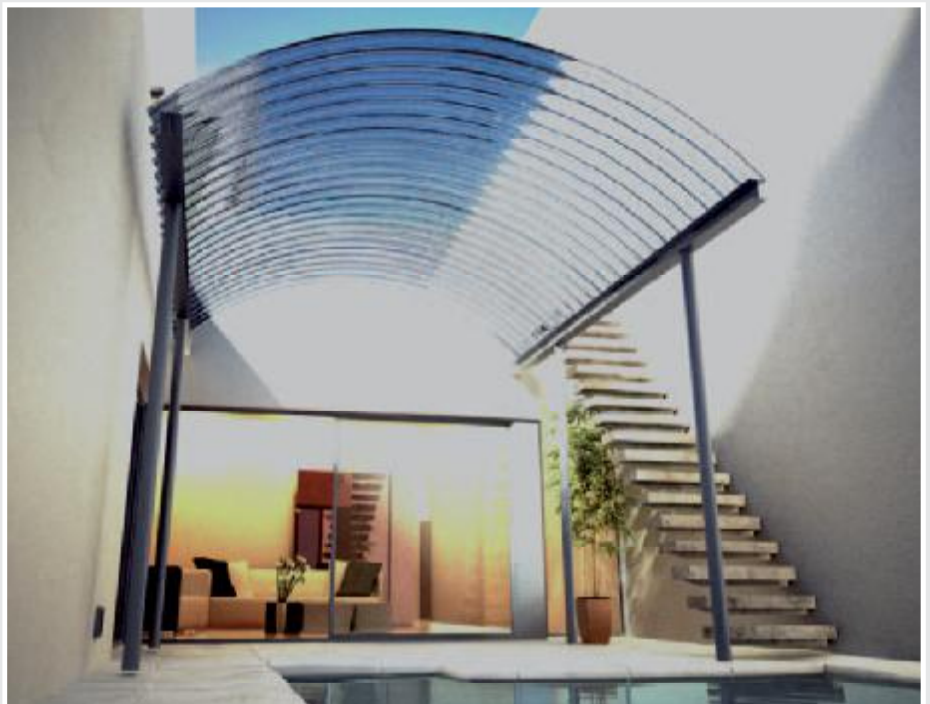



SKYLIGHT PANEL

Panels laterally overlap insulated corrugated roofing panels, or fibre cement sheets. Recommended minimum slope 7%.

CONTINUOUS ROOFING

Construction of continuous roofing with continuous lateral overlapping of polycarbonate panels. Components are manufactured with a bend radius of R.3.500mm.

CURVED SYSTEM LOAD RESISTANCE R.3.500

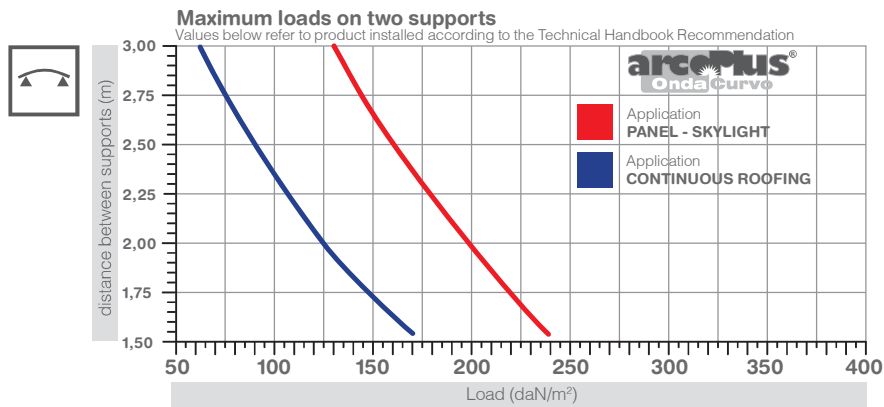

DEVELOPMENT TABLE R.3.500 mm

Span	Rise	Development
1.000	36	1.015
1.200	52	1.220
1.400	71	1.420
1.600	93	1.630
1.800	118	1.835
2.000	146	2.045
2.200	177	2.255
2.400	212	2.470
2.600	250	2.685
2.800	292	2.905
3.000	338	3.125

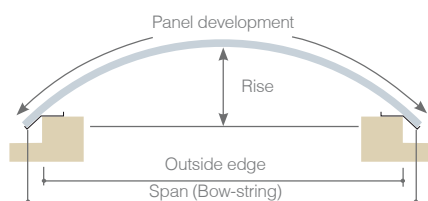

ACCESSORIES



4256
Gasket for gutter
PE-LD



4262 6,3 X 20
4261 6,3 X 90
4374 6,3 X 120
Fixing screw with Buzzer



4232
Sealant tape
PE-LD 20x10

ACCESSORIES

arcoPlus®Onda, system has a complete set of accessories enabling simple installation. The structure has fixing elements, and gaskets in order to increase resistance in overlapped areas. arcoPlus®Onda is delivered, as a standard product, with thermowelded extremities.

2.4 OPENING SYSTEMS

arcoPlus®
Openable System



PROFILE

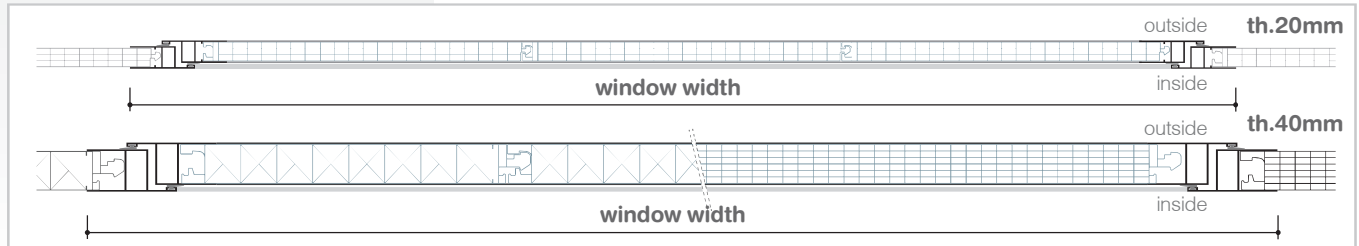

Openable windows in UV protected polycarbonate to ventilate buildings

DESCRIPTION

With the arcoPlus® opening systems, manually or motor-operated windows can be fitted into the curtain walling to ventilate the building.

These consist of suitably sized aluminium frames, which are housed in the same base profile used for the fixed part. The frames th.20mm are supplied complete with compass hinges for widths of up to 4 staves. External hinges are provided for widths of more than this (th.40mm).

The windows are supplied complete with gaskets.

The air cells of the polycarbonate panels must be sealed using vented aluminium breather tape.

This allows correct ventilation and prevents soiling on the inside.

CE EN 14351 -1

ADVANTAGES

- ❖ High load resistance
- ❖ Light transmission
- ❖ Resistance to U.V. rays and to hail
- ❖ Thermal insulation
- ❖ Easy to install

APPLICATIONS

 Vertical openable windows

PRODUCTION STANDARDS

arcoPlus® 524	th.20mm			
	WINDOW HEIGHT		WINDOW WIDTH	
	3 panels	4 panels	5 panels	6 panels
till 1.000mm	1.180	1.513	1.846	2.180
1.250mm	*	*	*	*
1.500mm	*	*	*	*
1.750mm	*	*	-	-

NB:
Opening systems with a thickness of 20mm that are more than 1.513mm (4 staves) wide, are supplied with external hinges.

arcoPlus® 544b	arcoPlus® 547	th.40mm			
		WINDOW HEIGHT		WINDOW WIDTH	
		3 panels	4 panels	5 panels	6 panels
till 1.000mm	1.250	1.580	1.915	2.250	*
1.250mm	*	*	*	*	*
1.500mm	*	*	*	*	*
1.750mm	*	*	-	-	-
2.000mm	*	*	-	-	-
2.250mm	*	*	-	-	-
2.500mm	*	*	-	-	-

arcoPlus® 547	CE EN 14351 -1	th.40mm			
		WINDOW HEIGHT		WINDOW WIDTH	
		2 panels	3 panels	4 panels	
till 1.000mm	1.250	1.750	2.250	*	*
1.250mm	*	*	*	*	*
1.500mm	*	*	*	*	*
1.750mm	*	*	-	-	-
2.000mm	*	*	-	-	-
2.250mm	*	*	-	-	-
2.500mm	*	-	-	-	-

NB:
Manually-operated opening systems with a thickness of 40mm are only supplied with the multi-function control.





WINDOWS DIMENSION

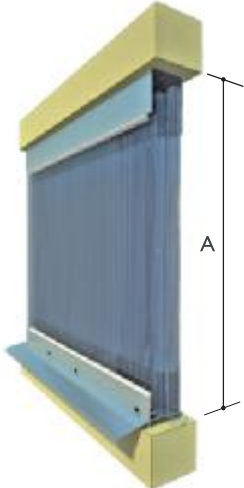

WITH EAVE

H. window th.20 = A-50mm
 H. window th.40 = A-50mm
 H. window th.40 = A-65mm (TT)

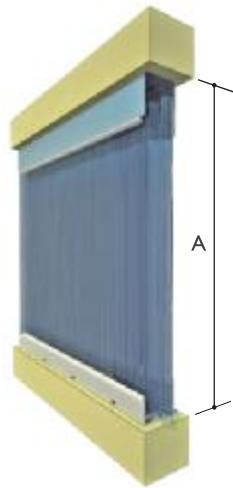

WITHOUT EAVE

H. window th.20 = A-40mm
 H. window th.40 = A-45mm
 H. window th.40 = A-60mm

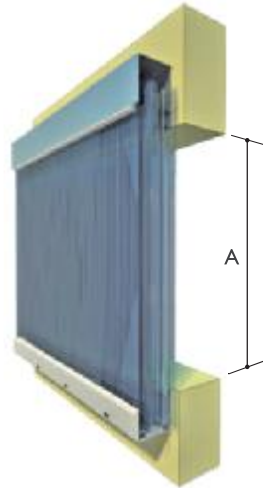

OUTSIDE OF THE BUILDING

H. window th.20 = A + 80mm
 H. window th.40 = A + 95mm

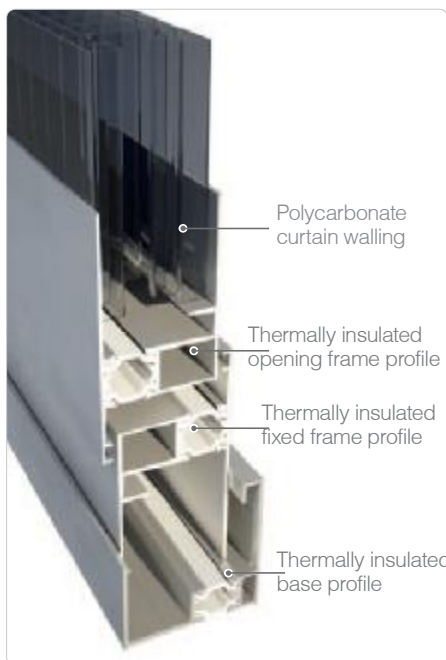

HINGED FRAMES WITH THERMAL ISOLATION

In order to guarantee the maximum thermal isolation and respect the air/light relation, hinged frame systems in arcoPlus® with thermally isolated aluminium profiles are available.

ACCESSORIES



4208
Electric motor



4209
Manually-operated handle



4210
Multi-function manual control



4309
External hinges for frame

3

MULTIWALL SHEETS

By concentrating on technological innovation and continuous research into the choice of raw materials and new methods of achieving UV protection, we have been able to develop a wide range of multiwall sheets, each with its own specific properties, to meet the demands of the various market sectors.

These products are classified according to their design and number of walls to make it easy to find the best product for each specific application.

The multiwall structure combined with the properties of polycarbonate ensure superior thermal insulation and excellent impact strength.

Policarb® sheets have UV protection on the side facing the exterior (both sides upon request) for good ageing resistance even after prolonged exposure to the sun and atmospheric agents.

Policarb® multiwall sheets are used for roofing, glazing, greenhouses, skylights, verandas, gazebos, shelters and false ceilings.

PoliCarb®

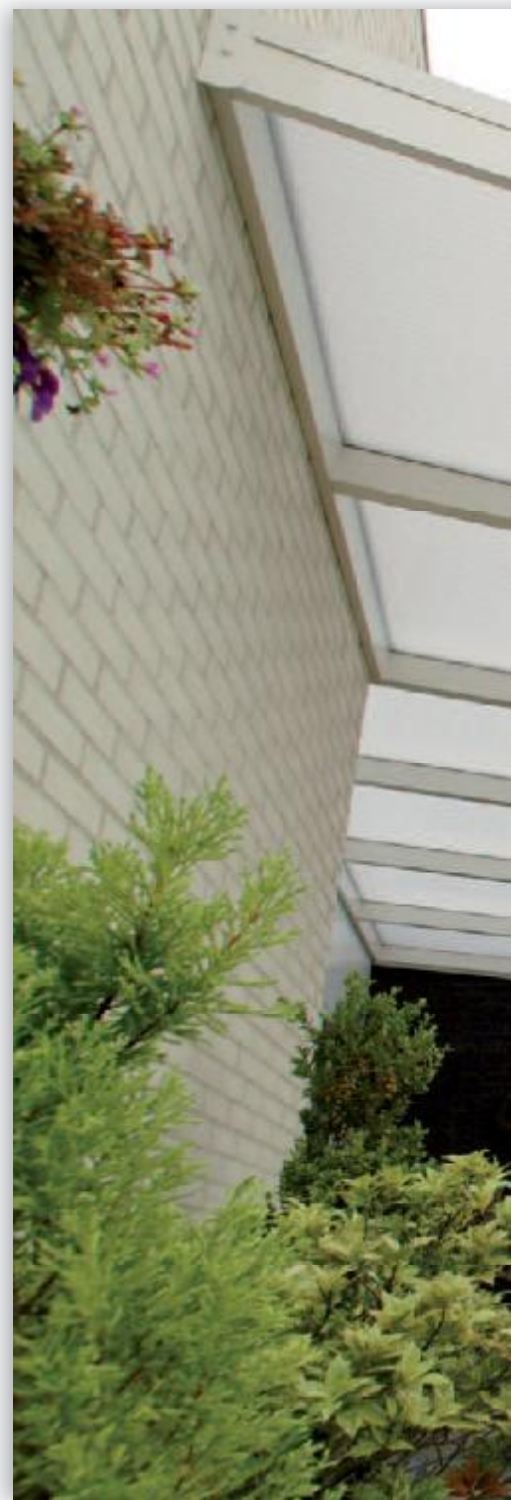



3.1 MULTIWALL SHEETS

PoliCarb®



PROFILES

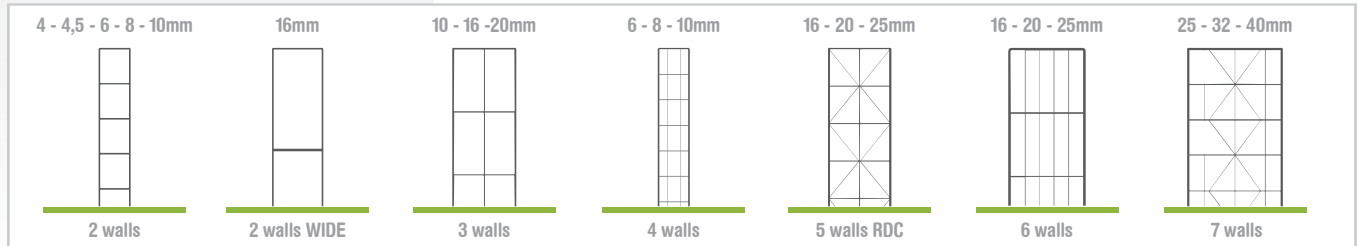





Multiwall U.V. protected polycarbonate sheets



ADVANTAGES

- ❖ Light transmission
- ❖ Resistance to U.V. rays and to hail
- ❖ Energy saving
- ❖ Economical
- ❖ Versatile

APPLICATIONS

-  Vertical windows
-  Roofing
-  Curved roofing
-  Ceiling

PRODUCTION STANDARDS

	structure	thickness	weight	U value	width	length
	walls	mm	Kg/mq	W/m²K	mm	mm
2 WALLS						
Policarb 2P-4mm	2	4	0,80	3,9	2.100	6.000
Policarb 2P-4,5mm	2	4,5	1,00	3,9	2.100	6.000
Policarb 2P-6mm	2	6	1,30	3,6	2.100	6.000
Policarb 2P-8mm	2	8	1,50	3,3	2.100	6.000
Policarb 2P-10mm	2	10	1,70	3,0	980-1.250-2.100	6.000
Policarb 16mm WIDE	2	16	3,90	2,5	980-1.250	6.000
3 WALLS						
Policarb 3P-10mm	3	10	2,10	2,7	980-1.250-2.100	6.000
Policarb 3P-16mm	3	16	2,70	2,3	980-1.250-2.100	6.000
Policarb 3P-20mm	3	20	3,20	2,1	980-1.250-2.100	6.000
4 WALLS						
Policarb 4P-6mm	4	6	1,40	3,1	2.100	6.000
Policarb 4P-8mm	4	8	1,55	2,7	2.100	6.000
Policarb 4P-10mm	4	10	1,75	2,5	2.100	6.000
5 WALLS						
Policarb 5P-16mm RDC	5	16	2,55	2,1	980-1.250-2.100	6.000
Policarb 5P-20mm RDC	5	20	3,10	1,8	980-1.250-2.100	6.000
Policarb 5P-25mm RDC	5	25	3,10	1,6	980-1.250-2.100	6.000
6 WALLS						
Policarb 6W-16mm	6	16	3,40	1,8	980-2.100	6.000
Policarb 6W-20mm	6	20	3,70	1,6	980-2.100	6.000
Policarb 6W-25mm	6	25	3,90	1,4	980-2.100	6.000
7 WALLS						
Policarb 7W-25mm	7	25	3,40	1,4	1.250	6.000
Policarb 7W-32mm	7	32	3,70	1,2	1.250	6.000
Policarb 7W-40mm	7	40	3,90	1,1	1.250	6.000

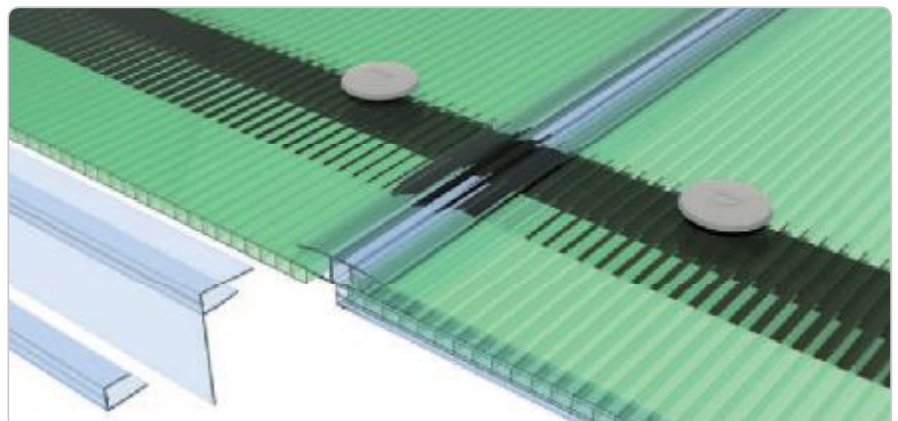

CONTINUOUS ROOFING
Detail of roof with H-shaped connector and air cell end profiles.



TECHNICAL FEATURES

Linear thermal expansion	0,065mm/m°C
Temperature range	-40°C +120 °C
U.V. protection	Coextrusion (both sides upon request)
Fire reaction EN 13501	EuroClass B-s1,d0

DESCRIPTION

The characteristic structure of the multi-wall sheets with air space inside guarantees good thermal insulation and excellent resistance to crash stress.

The external side of Polycarb® is coated with U.V. protection (on request both sides) warranting resistance to aging due to atmospheric agents and UV rays. Polycarb® is used for roofing, windows, skylights, greenhouses, porches, gazebos, ceilings.

LIGHT TRANSMISSION

High-resistance pigments (opal, bronze and green) are added to the polycarbonate to achieve different light transmission values. For values see the table on page 10.

SOLAR FACTOR

The solar factor is closely linked to the sheet structure.

It is the ratio, expressed as a percentage, between the total energy transmitted to the inside and total solar radiation.

THERMAL INSULATION

Heat loss is normally defined as thermal transmittance and referred to in physics as the "U-value".

It is the rate of heat loss through a unitary surface per degree centigrade difference in temperature between the two sides and depends on the properties of the material of which the structure is made and the linear thermal transmittance conditions.

SELF-EXTINGUISHING

Polycarb® sheets have Class 1 type approval and meet the EuroClass B-s1,d0 fire rating.

LOCK WASHERS

The sheets must be fastened to the structure using specific washers with a seal to guarantee a watertight finish and allow the material to expand due to changes in temperature.

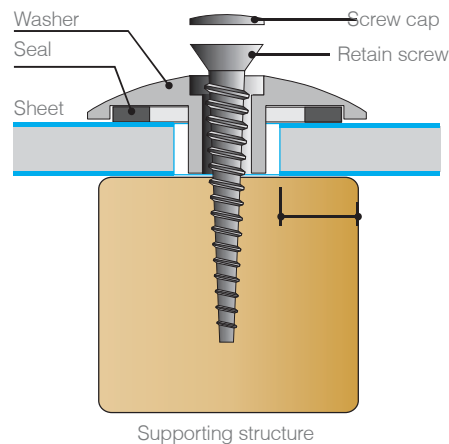

THERMOWELDING

Polycarb® sheets can be supplied welded at their ends, (up to 10mm th.) ensuring throughout time the cleanliness on the inside of the cells and greater transparency.

CLOSING TAPES

Adhesive steel tapes of varying heights for the closing of the cells are available:

- H. 19mm for sheets th. 4,5-6mm.
- H. 25mm for sheets th. 8-10mm.
- H. 38mm for sheets th. 16mm.
- H. 60mm for sheets th. 25-32-40mm.



PLANES SHEETS APPLICATION

The choice of sheet thickness is based on the requested values of snow/wind loads and on sheet dimensions.

LOAD RESISTANCE (daN/m²) FIXED PLANE SHEET ON 4 SIDES

Polycarb 2P-6mm				
length (m)	width (m)			
	0.70	0.60	0.50	0.40
1.00	50	80	105	120
1.50	45	75	105	110
2.00	40	70	100	110
2.50	35	65	90	100
3.00	35	65	90	100

Polycarb 4P-10mm					
length (m)	width (m)				
	1.20	1.00	0.90	0.70	0.50
1.00	60	70	85	90	145
1.50	40	65	75	80	140
2.00	30	60	70	75	135
2.50	25	60	65	70	130
3.00	25	55	60	70	115

Polycarb 3P-16mm					
length (m)	width (m)				
	1.20	1.00	0.90	0.80	0.60
1.00	105	135	150	175	230
1.50	70	125	140	150	220
2.00	70	120	135	140	150
2.50	70	110	110	135	145
3.00	60	90	100	130	140

Polycarb 5P-20mm RDC					
length (m)	width (m)				
	1.20	1.00	0.90	0.80	0.60
1.00	140	155	180	230	280
1.50	120	140	170	200	255
2.00	100	130	140	160	205
2.50	80	120	130	140	165
3.00	80	100	100	130	160

Polycarb 6W-16mm					
length (m)	width (m)				
	1.20	1.00	0.90	0.80	0.60
1.00	170	190	210	240	270
1.50	130	180	200	220	250
2.00	105	125	130	150	190
2.50	75	110	125	130	155
3.00	75	90	100	110	150

Polycarb 6W-25mm					
length (m)	width (m)				
	1.20	1.00	0.90	0.80	0.60
1.00	210	230	290	350	350
1.50	180	220	280	340	350
2.00	140	170	180	190	210
2.50	110	150	150	160	170
3.00	100	130	140	150	165

Polycarb 7W-32mm					
length (m)	width (m)				
	1.20	1.00	0.90	0.80	0.60
1.50	220	250	325	395	430
2.00	170	210	260	305	330
2.50	145	190	225	255	270
3.00	140	180	210	235	250

The indicated values in the following charts (in pressure and in depression).

Polycarb 2P-10mm					
length (m)	width (m)				
	1.20	1.00	0.80	0.70	0.50
1.00	70	80	100	110	170
1.50	50	75	90	100	165
2.00	40	70	85	90	165
2.50	30	70	75	85	160
3.00	30	65	70	80	140

Polycarb 2P-16mm WIDE					
length (m)	width (m)				
	1.20	1.00	0.90	0.80	0.60
1.00	175	205	220	240	275
1.50	130	185	205	220	265
2.00	110	130	145	155	200
2.50	75	110	110	120	160
3.00	75	95	95	110	155

Polycarb 5P-16mm RDC					
length (m)	width (m)				
	1.20	1.00	0.90	0.80	0.60
1.00	120	140	160	200	250
1.50	100	130	150	190	230
2.00	90	120	130	140	180
2.50	70	100	100	110	145
3.00	70	85	85	100	140

Polycarb 5P-25mm RDC					
length (m)	width (m)				
	1.20	1.00	0.90	0.80	0.60
1.00	200	220	285	350	350
1.50	180	210	275	340	350
2.00	130	170	175	180	210
2.50	100	140	145	150	165
3.00	90	130	135	140	160

Polycarb 6W-20mm					
length (m)	width (m)				
	1.20	1.00	0.90	0.80	0.60
1.00	190	210	230	270	300
1.50	160	200	220	240	290
2.00	120	150	150	170	205
2.50	90	130	140	145	165
3.00	80	110	110	135	160

Polycarb 7W-25mm					
length (m)	width (m)				
	1.20	1.00	0.90	0.80	0.60
1.50	180	240	315	385	390
2.00	170	200	240	280	275
2.50	145	170	195	215	240
3.00	140	165	190	210	235

Polycarb 7W-40mm					
length (m)	width (m)				
	1.20	1.00	0.90	0.80	0.60
1.50	240	255	330	400	450
2.00	180	215	265	315	355
2.50	155	190	230	265	280
3.00	150	185	215	245	255



COLD BENDED SHEET APPLICATION

In particular Policarb® is used to build integral are structures green house tunnel type since its alveolar structure increases

the rigidity of the sheet longitudinally bent at its ribs.

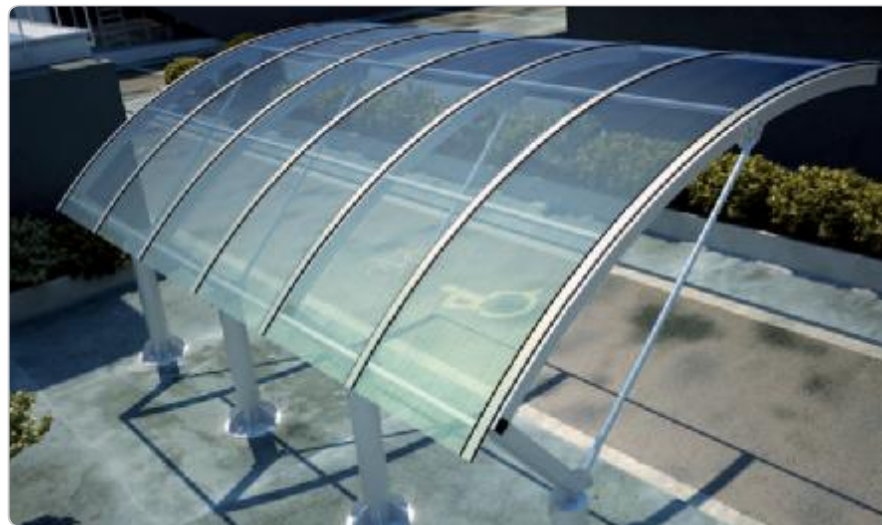

MINIMUM RADIUS OF CURVATURE

sheet thickness	4,5-2P	6-2P	10-2P	10-4P	16-3P	16-RDC	16-6W	20-RDC	20-6W	25-7W	32-7W	40-7W
radius (mm)	750	1.000	1.750	2.000	2.800	3.500	2.800	4.000	3.400	DO NOT BEND		

LOAD CAPACITY (daN/m²) FIXED SHEETS COLD BENDED ON 4 SIDES

radius (m)	sheet thickness (mm)															
	6				8				10				16			
width sheet (m)													16RDC			
1.00	1.80				1.50				1.25				1.07			
1.20	1.50				1.25				1.00				0.90			
1.40	1.20	1.90			0.96	1.70			0.83	1.30			0.72	1.10		
1.60	1.00	1.65			0.82	1.27			0.68	1.06			0.60	0.92		
1.80	0.80	1.23	1.68		0.64	1.00	1.38		0.58	0.84	1.18		0.73	1.02		
2.00	0.75	1.15	1.60		0.60	0.92	1.28		0.55	0.78	1.08		0.68	0.93		
2.20	0.67	0.98	1.35		0.82	1.12			0.70	0.95			0.82			
2.40	0.60	0.88	1.23		0.70	1.00			0.84				0.74			
2.60		0.75	1.07			0.90										
2.80		0.93	1.92			1.58				1.33				1.15		
3.00		0.88	1.78			1.45				1.21				1.06		
3.20		0.83	1.62			1.32				1.11				0.97		
3.40		0.75	1.48			1.24				1.07				0.95		
3.60		1.40	1.60			1.20	1.25			1.04	1.15			0.92	1.00	
3.80		1.30	1.50			1.15	1.20			1.00	1.12			0.90	1.00	
4.00		1.20	1.38			1.10	1.15			1.05				0.97		
4.20		1.20	1.35			1.10				1.00				0.95		
4.40		1.12	1.28			1.07				0.98				0.95		
4.60		1.20				1.05				0.98				0.93		
4.80		1.15				1.00				0.95				0.90		
load	80 daN/m ²				100 daN/m ²				120 daN/m ²				140 daN/m ²			

ACCESSORIES

-  **1298** th.8mm
-  **1164** th.10mm
-  **1165** th.16mm
-  **1300** th.20mm
- Profiles "H" U.V. protected

-  **1296** th.8mm
-  **1160** th.10mm
-  **1161** th.16mm
-  **2184** th.20mm
-  **2260** sp.30mm
- Profiles "U" U.V. protected

-  **2191** th.8-10mm
-  **2192** th.16mm
- Profiles "R" U.V. protected

-  **2193** th.8-10mm
-  **2194** th.16mm
- Profiles "F" U.V. protected

-  **4285** th.10mm
-  **4286** th.16mm
- "U" aluminium profile

-  **4272** th.2-10mm
-  **4279** th.16-20mm
- Upper aluminium profile

-  **4273** th.2-10mm
-  **4280** th.16-20mm
- Side aluminium profile

-  **4077** th.4-6mm
-  **4076** th.8-10mm
-  **4087** th.16mm
- Washer with gasket

-  **4276** th.3-6mm
-  **4324** th.8-20mm
- Gasket for aluminium profile

4

SOLID SHEETS

The solid polycarbonate sheets offer a combination of unsurpassed features: resilience, transparency, lightness.

As clear as glass weigh half as much and are 250 times more impact resistant. They have also, better thermal and acoustic insulation properties.

For this reason they have a high versatility and can be worked either hot or cold, thus becoming eligible for all interventions in the Construction sector and Industry.

ADVANTAGES OF SOLID SHEETS ARE:

- transparency
- extreme impact strength
- good fire reating

PoliComp[®]
Scudo[®]





4.1 SOLID SHEETS

PoliComp®

← 2.500mm →



Polycarbonate solid sheets with U.V. protection on both sides

DESCRIPTION

The development of extrusion technology have allowed the construction of a plant in Europe for the production of solid polycarbonate sheets with width of 2,500 mm of various thicknesses and colors.

The polycarbonate product range is divided into solid Policom® sheets, with UV protection on both sides. And Scudo® sheets, no UV protected ideal for industrial applications.

PRODUCTION STANDARDS

thickness (mm)	2	3	4	5	6	8	10	12
weight (Kg/m ²)	2,4	3,6	4,8	6,0	7,2	9,6	12,0	14,4
width (mm)	2.050 - 2.500							
length (mm)	6.100							

PRODUCT AVAILABLE
WITH IR TREATMENT

ADVANTAGES

- ❖ Only plant that produces up to 2.500 width
- ❖ Light transmission
- ❖ Resistance to U.V. rays and to hail
- ❖ Impact strength
- ❖ Easy to process

APPLICATIONS



Vertical windows



Roofing



Curved roofing



False ceiling

SAFETY

Scudo® sheets are used in safety glazing applications, for machine tool guards.

Policomp® sheets are used instead for build roof, vertical windows and advertising signs.

LIGHTNESS

Compared to normal glass structures, Policom® and Scudo® sheets considerably reduce the weight of the structures. A solid polycarbonate sheet weighs 50% less than a sheet of glass of the same thickness.

LIGHT TRANSMISSION

Policomp® sheets have good light transmission properties and are also available in bronze and opal.

ENERGY SAVING

Policomp® sheets provide excellent thermal insulation, an important factor in reducing fuel consumption for heating buildings.

DURABILITY

Policomp® sheets are guaranteed for durability. (see terms of warranty)

COEXTRUSION

A layer of high-performing UV absorber is coextruded onto both sides of Policom® sheets. This filters the light and protects the polymer against the effects of ageing, ensuring excellent impact strength even after prolonged exposure to sunlight.

UV PROTECTION ON TWO SIDES

Policomp® sheets have UV protection on both sides.

SELF-EXTINGUISHING

The solid polycarbonate sheets have Class1 type approval in thickness from 8mm to 12mm, and meet the EuroClass B-s2,d0 fire rating in accordance with the European legislation for thickness from 2mm to 6mm.



PHYSICAL PROPERTIES

	value	unit	test metod
density	1,2	gr/cm ³	ISO 1183
moisture absorption 23°C	0,15	%	ISO 62-4
refractive index 20°C	1.586	-	ISO 489

MECHANICAL PROPERTIES

	value	unit	test metod
resistance to tensile stress	>60	MPa	ISO 527-2
elongation at yield	6	%	ISO 527-2
elongation at break	>70	%	ISO 527-2
elastic modulus	2.400	MPa	ISO 527-2
limiting flexural stress	ca.90	MPa	ISO 178
impact strength (Charpy, unnotched)	no break	KJ/m ²	ISO 179
impact strength (Charpy, notched)	ca.11	KJ/m ²	ISO 179

THERMAL PROPERTIES

	value	unit	test metod
Vicat softening temperature	148	°C	ISO 306
thermal conductivity	0,2	W/m°C	DIN 52612
linear thermal expansion	0,065	mm/m°C	DIN 53752

ELECTRICAL PROPERTIES

	value	unit	test metod
dielectric strength	35	kV/mm	IEC 60243-1
volume resistivity	0,15	%	ISO 62-4
surface resistivity	1.586	-	ISO 489

LIGHT TRANSMISSION (%)

thickness (mm)	2	3	4	5	6	8	10	12
color								
transparent	91	90	90	90	88	86	80	80
bronze	-	44	48	51	50	-	-	-
green	-	-	28	-	42	-	-	-
blue	-	-	-	-	11	-	-	-
opal	-	53	50	40	38	-	-	-

THERMAL INSULATION U (W/m²K)

thickness (mm)	2	3	4	5	6	8	10	12
Polycomp	5,66	5,49	5,33	5,21	5,09	4,84	4,61	4,35
Glass	-	5,87	5,82	5,80	5,77	5,71	-	-

ACOUSTIC INSULATION (dB)

thickness (mm)	2	3	4	5	6	8	10	12
Value	25	26	27	28	29	31	33	34

WEIGHT (Kg/m²)

thickness (mm)	2	3	4	5	6	8	10	12
Polycomp	2,4	3,6	4,8	6,0	7,2	9,6	12,0	14,4
Glass	5	7,5	10	12	15	20	25	30

The solid polycarbonate sheets in the extensive Polycomp® range offer extreme transparency.

They are ideal for applications that require superior thermal and sound insulation combined with a

lightweight structure with good impact strength.

Polycomp® sheets are as clear as glass, weigh half as much and are 250 times more impact resistant.



APPLICATION OF FLAT SHEETS

Solid polycarbonate sheets can be installed in most PVC, wood, steel and aluminium structures and frames.

The frame must hold the sheet in place while allowing it to expand. The choice of sheet thickness depends on the load value required. According to the size of the sheet, from table A, the effective area and also the thickness will be calculated.

Table B can be used to calculate the thickness of the sheet to be used according to the size of the sheet (AREA) and the required load value.

The values shown in table B (positive and negative loads) have been calculated for sheets fixed on four sides, with a maximum bend value (rise) of 50mm.



SHEET SIZE

sheet length (m)	sheet width (m)								
	0.25	0.50	0.75	1.00	1.25	1.50	1.75	2.00	
0.25	A1	A1	A1	A1	A1	A1	A1	A1	A1
0.50	A1	A2	A3	A4	A4	A4	A4	A4	A4
0.75	A1	A3	A5	A6	A7	A7	A7	A7	A7
1.00	A1	A4	A6	A8	A9	A9	A10	A10	A10
1.25	A1	A4	A7	A9	A10	A11	A12	A13	A13
1.50	A1	A4	A7	A9	A11	A13	A14	A15	A15
1.75	A1	A4	A7	A10	A12	A14	A16	A17	A17
2.00	A1	A4	A7	A10	A13	A15	A17	A18	A18
2.25	A1	A4	A7	A10	A13	A16	A18	A19	A19
2.50	A1	A4	A7	A10	A14	A16	A19		
2.75	A1	A4	A7	A11	A14	A16	A19		
3.00	A1	A4	A7	A11	A14	A17	A19		
3.25	A1	A4	A7	A11	A14	A17			
3.50	A1	A4	A7	A11	A14	A17			
3.75	A1	A4	A7	A11	A14	A17			
4.00	A1	A4	A7	A11	A14	A17			
4.25	A1	A4	A7	A11	A14	A17			
4.50	A1	A4	A7	A11	A14	A17			
4.75	A1	A4	A7	A11	A14	A17			
5.00	A1	A4	A7	A11	A14	A17			

TABLE A

CHOICE OF THICKNESS

AREA	load (daN/m²)				
	60	80	100	120	140
A1	3	3	3	3	3
A2	3	3	4	4	4
A3	4	4	4	4	5
A4	4	4	5	5	6
A5	5	5	5	5	6
A6	5	6	6	6	8
A7	6	6	8	8	8
A8	6	6	8	8	8
A9	8	8	8	8	10
A10	8	8	10	10	10
A11	10	10	10	10	12
A12	10	10	10	12	12
A13	10	10	10	12	
A14	10	12	12		
A15	10	12	12		
A16	10	12	12		
A17	12	12			
A18	12	12			
A19	12				

TABLE B



INSTALLATION GUIDELINES

When cutting sheets to allow for thermal expansion special care must be taken to avoid applying stress to the material.

Tolerance must be provided both widthwise and lengthwise.

The table at the side shows the sheet cutting values, depending on the size of the frame, in order to allow for thermal expansion.

The edge fitting must be deep enough to allow the material to ex-

pand and also to prevent the sheet from escaping from the frame.

frame (mm)	sheet cut (mm)
300 - 1.000	3
1.000 - 1.300	4
1.300 - 1.700	5
1.700 - 2.000	6
2.000 - 2.300	7
2.300 - 2.700	8
2.700 - 3.000	9

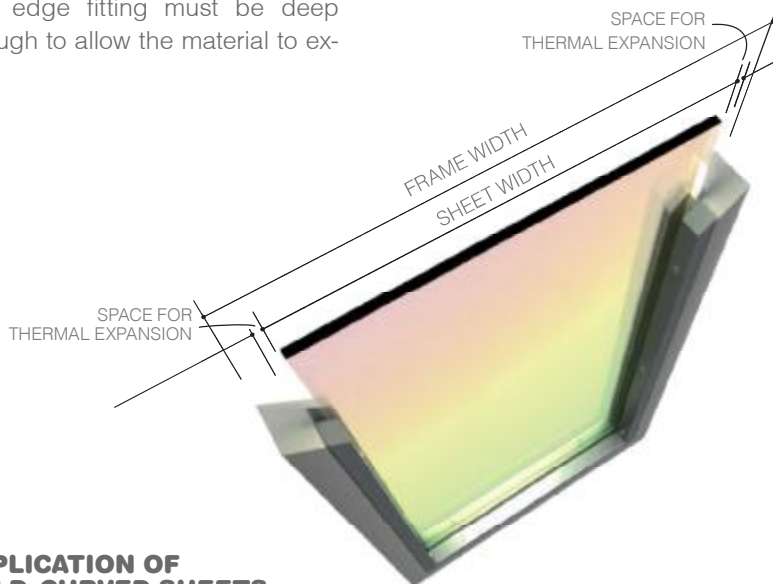

APPLICATION OF COLD-CURVED SHEETS

Policomp® is ideal for building integral arch or tunnel structures.

The minimum bend radius is 150 times the thickness of the sheet.

Example:

Sheet thickness: 3mm

Min. radius = 3 x 150 = 450mm

The choice of sheet thickness depends on the bend radius R but also on the width of the sheet W. The length L must always be greater than the width W.

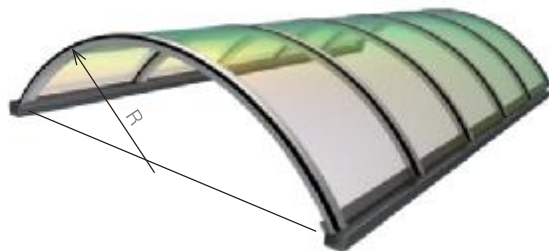

MINIMUM BEND RADIUS

thickness (mm)	2	3	4	5	6	8	10	12
radius (mm)	300	450	600	750	900	1.200	1.500	1.700



The graphs indicate the appropriate sheet thickness, for different bend radii, under different load conditions. These values have been calculated with sheets fixed on three sides.

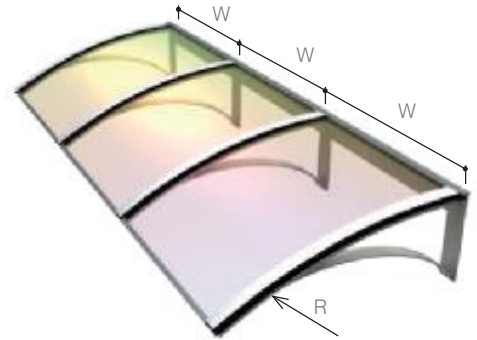

LOAD RESISTANCE

PoliComp®

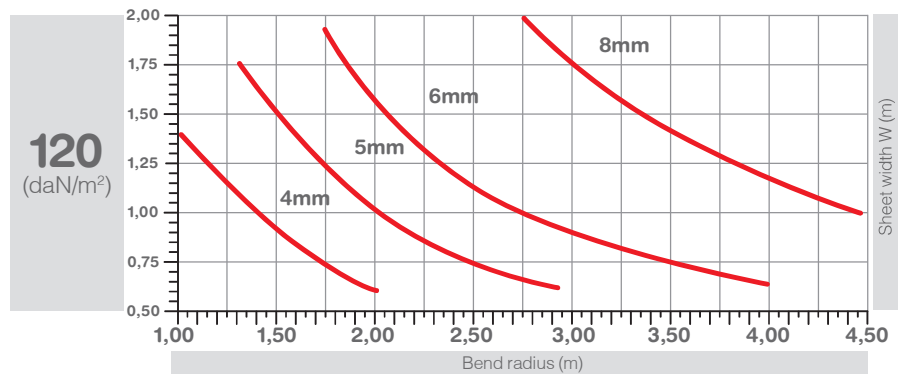
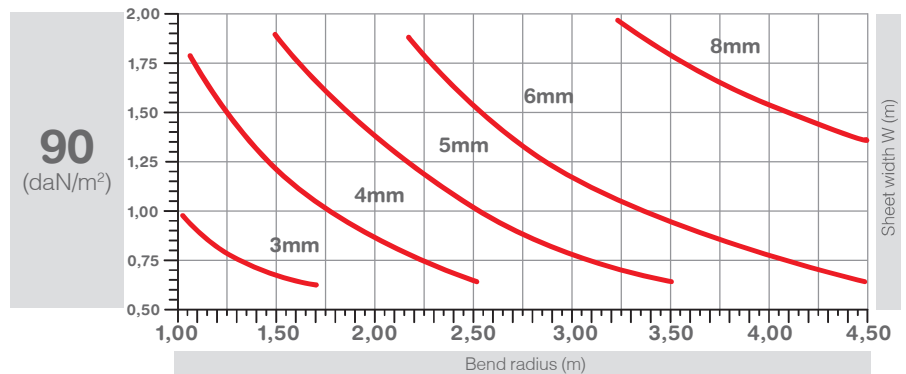
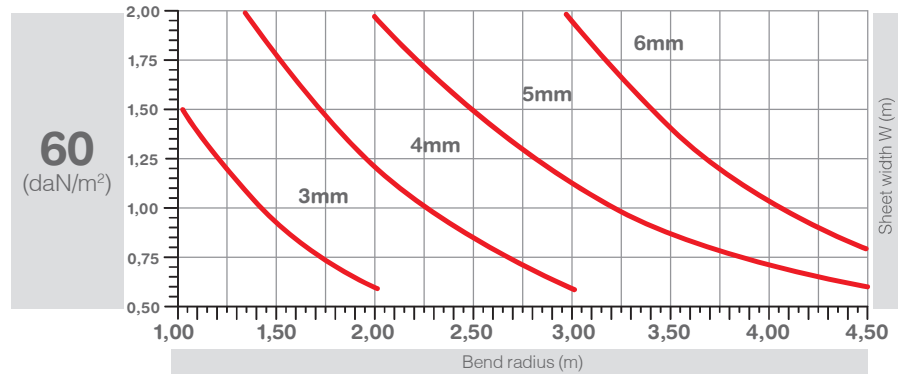



4.2 SOLID SHEETS

Scudo®

MATERIAL PROCESSING

CUTTING

Policomp® and Scudo® sheets can be cold-formed mechanically using standard high-speed tools to perform cutting, bending and drilling. Notches, which undermine the me-

chanical properties of the polycarbonate, are not recommended.

	circular saw	belt saw	milling machine
rake angle	20° - 30°	20° - 30°	20° - 30°
angle of inclination	15°	0,5°	0° - 5°
cutting speed (m/min)	1.800 - 2.400	600 - 1.000	100 - 500
feed speed (m/min)	19 - 25	20 - 25	0,1 - 0,5
distance between teeth (mm)	2 - 5	1,5 - 2,5	-

DRILLING

Policomp® and Scudo® sheets can be drilled using standard drilling machines that meet the following specifications:

parameter	value
rake angle α	5°-8°
angle of tip φ	90°-130°
angle of blade β	approx. 30°
angle of inclination γ	3°-5°
cutting speed	10-60 m/min
tip speed	0,1-0,5 mm/rev

Drill sheets as follows to avoid any damage during machining:

Drill the hole at a distance from the edge of the sheet equal to at least 1.5 times the diameter of the hole.

Do not use cutting oil.

Use threading if there is no other alternative. Sheets could break after drilling.

GLUING SHEETS

Neutral and compatible with polycarbonate adhesives should be used to glue the solid polycarbonate sheets.

THERMOFORMING AND HOT-CURVING

Remove the protective film before thermoforming and pre-heat the material to 120°C to eliminate any moisture that has been absorbed. The use of an air circulating oven with temperature control is recommended.

The air must circulate between the sheets.

Pre-heating times can be reduced by one third by storing the sheets in a dry place. Since the dry sheets start to re-absorb moisture as soon as they cool down to below 100°C, thermoforming must be performed immediately after drying.

Hot curving must be performed at a temperature of between 155°C and 165°C.

CLEANING OF SURFACES



We recommend the use of warm water and a soft cloth to clean Policomp® and Scudo® sheets.

Polycarbonate solid sheets WITHOUT UV PROTECTION

ADVANTAGES

- ❖ Easy and low-cost installation
- ❖ Light transmission
- ❖ Heat insulation
- ❖ Self-supporting

APPLICATIONS

-  Room partitions
-  False ceilings
-  Machinery protection guards

GENERAL TERMS AND CONDITIONS OF SALE



dott.gallina

1) ORDERS:

Orders are only valid if they refer to the price-list currently in force and are signed by way of the buyer's full acceptance of these terms and conditions of sale. The order is binding on the buyer and may only be cancelled with the written consent of Dott. Gallina S.r.l., subject to repayment of all costs claimed by the latter. The order becomes effective upon receipt of the confirmation of order signed by the buyer. All measurements in the order are taken as having been checked and verified by the buyer and are the responsibility thereof. Likewise, the buyer is responsible for controlling and verifying the qualities and purchase prices agreed upon with the seller.

2) DELIVERY:

The delivery date specified in the order and in the confirmation of order is indicative and thus not binding on Dott. Gallina S.r.l. Delays in delivery shall not give rise to any refund, compensation for damages or cancellation of the order. The buyer may not refuse to accept the goods until 45 days after the scheduled delivery date. After that date the buyer may cancel the order or insist upon delivery; in either case, notwithstanding the provisions of the law, the parties expressly waive any claims for compensation. Dott. Gallina S.r.l. shall not be answerable for delays due to unforeseeable circumstances, including accidents, machine breakdowns, strikes, lack of deliveries of raw materials, etc.

3) PACKAGING:

Unless otherwise expressly requested all materials shall be supplied in white polyethylene packaging and closed at the top. Where possible, but not necessarily, materials shall be strapped to pallets.

4) TRANSPORTATION:

Goods are transported at the buyer's risk, even though they are delivered free to destination and unloaded from the vehicle. Any complaints in connection with differences in the goods supplied, shortage of packages or damage must be reported to the carrier immediately at the time of delivery and clearly indicated in the transport document. Any complaints, including those in connection with orders made through an intermediary, must be made in writing directly to Dott. Gallina S.r.l. and sent by means of registered post to reach the latter within 8 days from the date of delivery.

5) WARRANTY:

(See terms and conditions of warranty). The warranty period starts from the date of invoice and the warranty is valid in accordance with the terms set forth in the certificates issued by the company. Dott. Gallina S.r.l. reserves the right to make any changes it deems necessary and without prior notice and shall not be liable for any direct or indirect loss or damage to persons or property arising in connection with the use of the product.

6) TOLERANCE:

Unless otherwise specified, sizes may vary by ± 2 mm/m with a minimum of ± 5 mm. Under no circumstances are product weights binding. Weights are provided to assist customers in their choice of product.

7) PAYMENT:

Dott. Gallina S.r.l. shall only accept new orders if all previous materials supplied have been paid for. Payments shall be made according to the agreed terms of payment and shall not be suspended or postponed for any reason or in connection with any claim. In the event of delayed payment interest will be charged at the equivalent of the three-month Euribor rate plus seven percent applicable as from the scheduled payment date up until the actual date on which said payment is made. Only under exceptional circumstances may the buyer request to postpone the contractual and confirmed delivery date, in which case the buyer shall agree to the goods being invoiced and to the relative payment falling due as from the date on which the goods become ready, in addition to sustaining all costs of handling and storage and any other related charges.

8) DISPUTES:

Any disputes arising in connection with these terms and conditions of sale shall be brought exclusively before the Court of Turin for settlement.

